

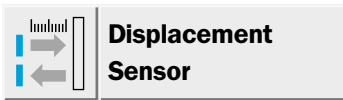

Displacement Sensor 0D

SICK



Displacement
Sensor

Scanner and measuring system at the same time



The displacement sensors of the OD series are scanners and measuring systems at the same time. Thanks to intelligent microcontroller technology, we have been able to combine all functions in a compact device for the first time: precise measuring and reliable presence control, this sensor can do both.

The calibration of the analog output and the setting of the scanning range of the control output is easy with Teach-in.

There are components in almost all manufacturing sectors that must fulfill the highest demands for precision and optics. The displacement sensors of the OD series detect the smallest deviations, depressions or lack of flatness immediately even in the μm range.

Type with metal housing and a class 2 laser is suited for applications that require the smallest spot dimensions for precise measuring. The plastic model OD 25 with red LED light source is suited for large-area recording of raw surfaces.

Temperature ranges between -10 and $+40$ °C as well as humid or dusty environments are no longer a problem.

▼ **The all-in-one sensor with proven PSD technology:** The proven triangulation measurement is the physical basis of the displacement sensor in the OD series. Optics, switches and signal processing are designed for the highest resolutions with simultaneously high linearity.

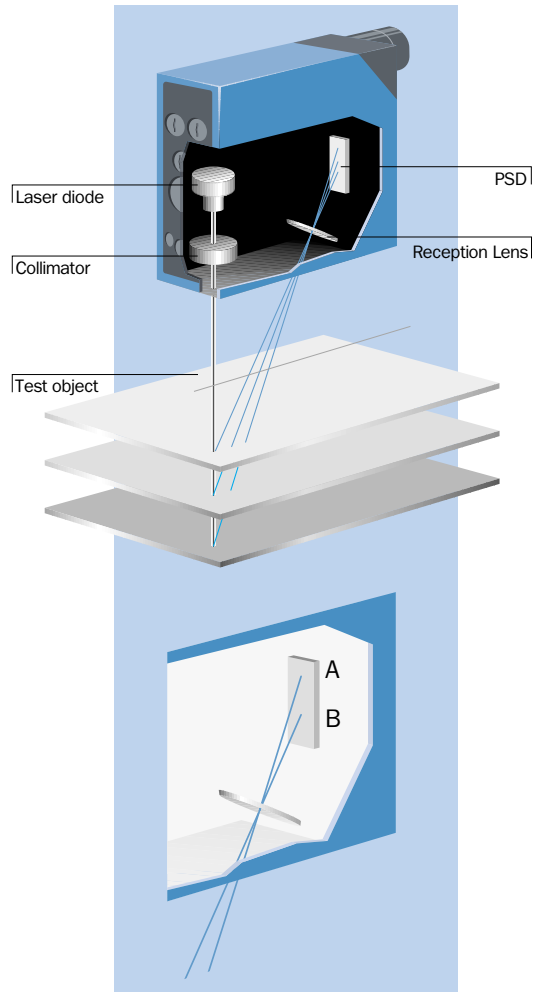

▲ **Triangulation measurement:** The site of the light spot on the PSD detector is dependent on the distance of the detected object. The signals A and B change depending on the position of the light spot. The calculation of the signals in the microcontroller then gives a linear output signal depending on the distance of the object.

▼ **Automobile industry:** Measuring raw and low-reflection engine and gear components with an OD displacement sensor. Localization and checking of welds and bodywork parts in passenger car mass production. Multicolored surfaces are detected reliably.

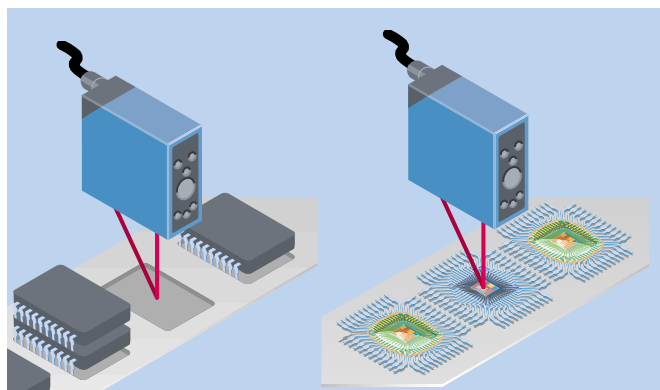

◀ **Semiconductor industry:** Measuring the epoxy resin deposit in IC manufacturing with the OD displacement sensor. Detection of missing ICs in the packaging of blister tapes. The OD is also designed for low-reflecting, light-absorbing surfaces.

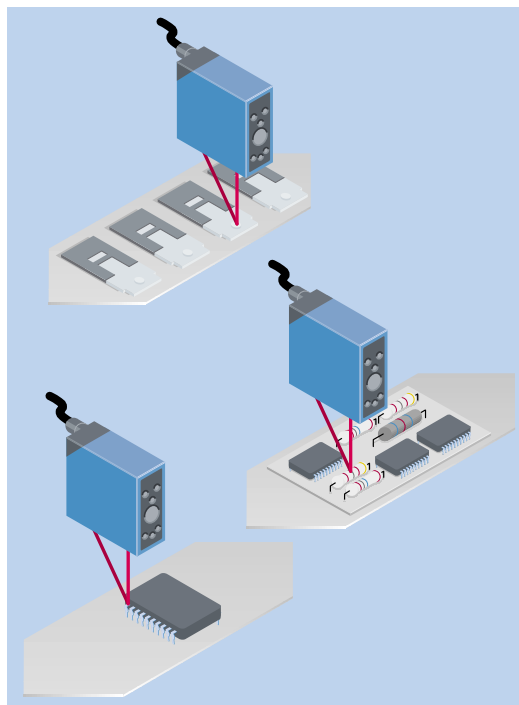
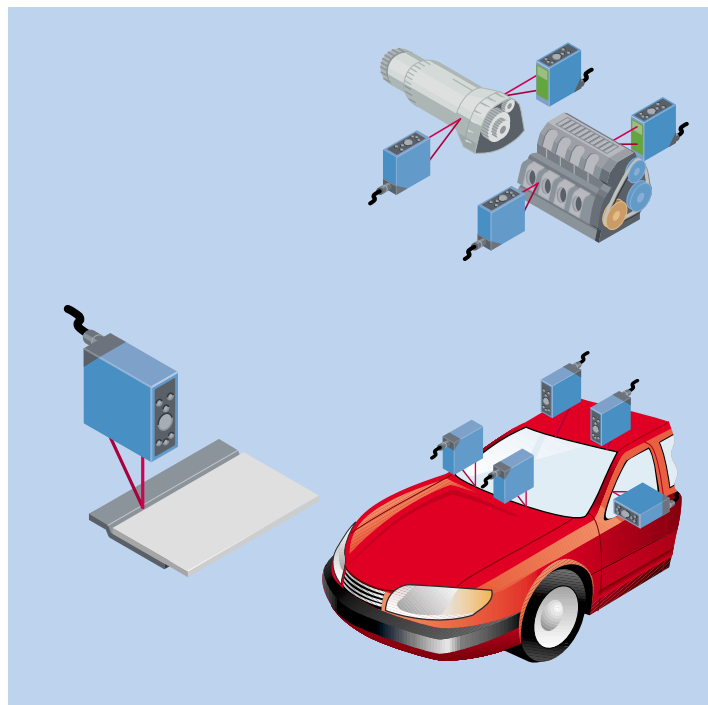

◀ **Electronics industry:** Checking the switching behavior of relay contacts and mechanical switches with an OD displacement sensor. Checking the IC contacts before assembling boards. Making sure whether electrical components are present.

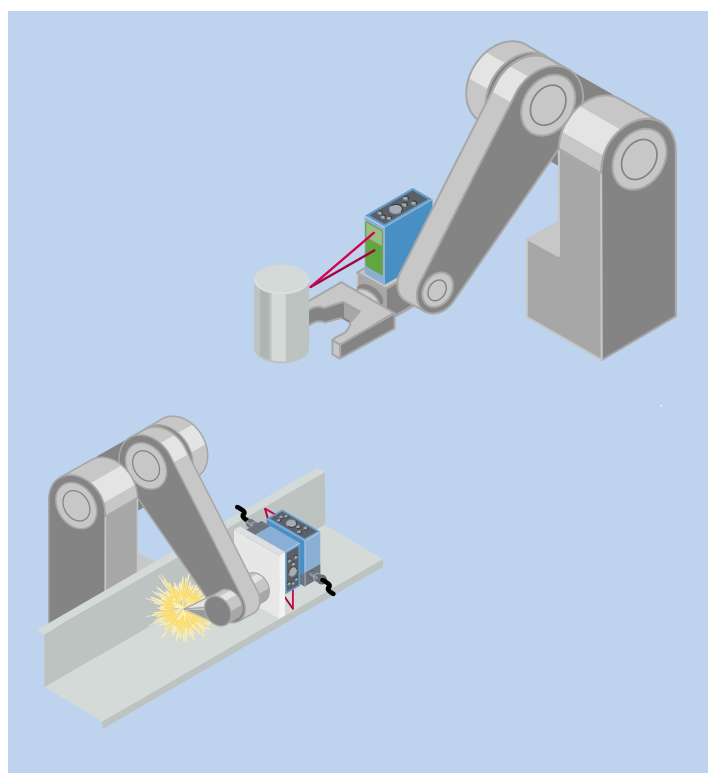

▲ **Robotics:** Alignment and targeted control of robot arms and control of welding robots in special purpose engineering or in mass production with an OD displacement sensor.

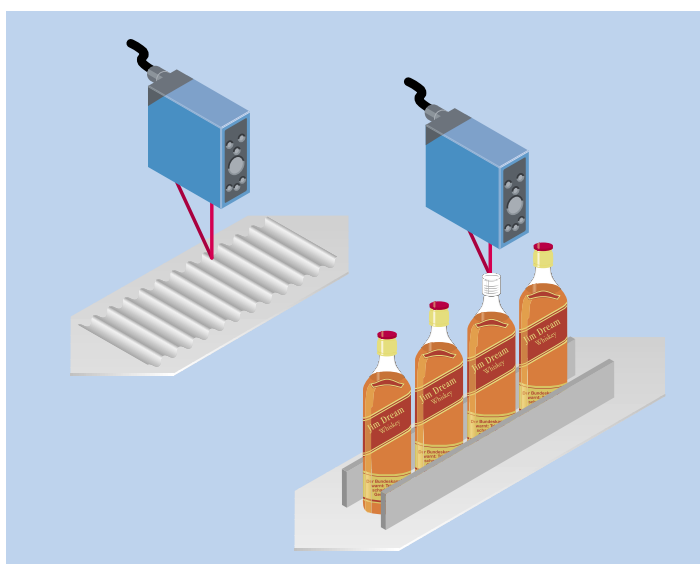

▲ **Paper and packaging industry:** Checking wave shapes and heights in cardboard production in cardboard packaging. The large light spot of the LED model enables measuring raw surfaces. Presence checks and checks of the curves of bottles and beaker caps. Multicolored surfaces do not affect the measuring behavior.

Displacement Sensor

- Setting and calibration with Teach-in
- Laser and LED models
- Blanking input for synchronization for demanding measurement jobs



Description of the operating panel

Setting options

| | |
|--------------|--------------|
| OD 25-05P132 | OD 50-10P142 |
| OD 25-05P830 | OD 50-10P840 |
| OD 25-05N132 | OD 50-10N142 |
| OD 25-05N830 | OD 50-10N840 |

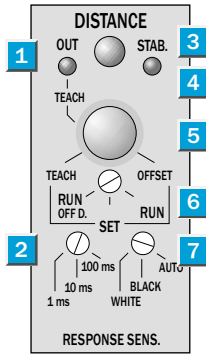

Setting options

| | |
|---------------|----------------|
| OD 30-04P142 | OD 130-50P142 |
| OD 30-04P840 | OD 130-50P840 |
| OD 30-04N142 | OD 130-50N142 |
| OD 30-04N840 | OD 130-50N840 |
| OD 100-35P142 | OD 250-150P142 |
| OD 100-35P840 | OD 250-150P840 |
| OD 100-35N142 | OD 250-150N142 |
| OD 100-35N840 | OD 250-150N840 |

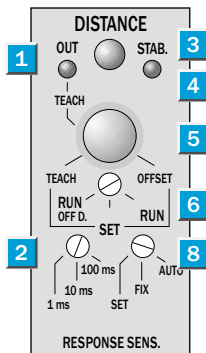

- 1** Output indicator/Teach-in indicator
In the RUN mode, the LED display shows the “open collector” status: orange = output ON; off or does not light = output OFF.
- 2** Response time with 3 positions
The positions 100 ms, 10 ms, and 1 ms are selected depending on the desired response time and resolution. The longer the response time, the better the resolution.
- 3** Distance indicator (DISTANCE)
Display for the distance from the sensor front to the object. In the scanning range: LED display lights red (closer than middle), orange (middle), or green (farther than middle). This distance indicator blinks red-green when the object is out of the measurement range.
- 4** Stable indicator (STAB.)
The LED display lights green when there is light reception with reserve. It does not light when there is sufficient reception, and it lights red if reflectance is too weak or strong.
- 5** Teach-in button – Set mode (during Teach-in)
 - Setting the scanning distance: The LED lights green 1x when the first distance is set and 2x when the second distance is set. It lights red 1x if there is an operating error.
 - Setting the offset: The LED lights green 3x when the offset is set. It lights red 1x if there is an operating error.
 - Resetting the offset: The LED lights green 3x when the offset is reset.
- 6** Mode selector with 3 positions
The positions SET, RUN, and RUN with OFF DELAY are required for Teach-in.
- 7** OD 25/OD 50:
Sensitivity selector with 3 positions WHITE (white object), BLACK (black object), and AUTO (gray and/or multicolored object). WHITE or BLACK is selected dependent on the reflection when the selector is set to AUTO.
- 8** OD 30/OD 100/OD 130/OD 250:
AUTO: Automatic amplifier control (gain) depending on reflectance.
SET/FIX: Switch setting SET: Reflectance is taught by Teach-in. Switch setting FIX: Amplification is set after Teach-in with the switching function FIX.

Description of the blanking input (SH)

- When the blanking input is active, the control and the analog output retain their previous status (PNP type: active – level is HIGH; NPN type: active – level is LOW.)

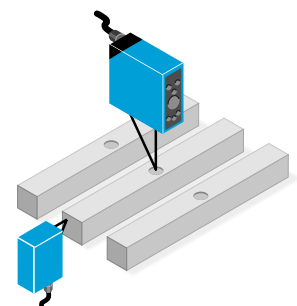
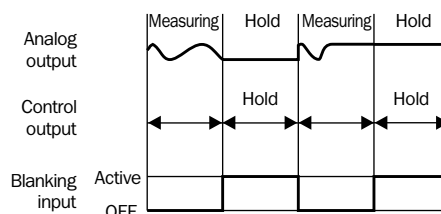

Beschreibung Funktionen

Two steps for calibrating the analog output

1. Position the object at the average scanning distance. The LED distance indicator lights orange.
2. Switch the Mode selector to SET. Press the Teach-in button for 2 to 5 seconds or trigger it via the connecting cable. The Teach-in display lights green 3x. Switch the Mode selector to RUN or RUN with OFF DELAY: the calibration is adopted.

The Teach-in input is independent of the position of the Mode selector.

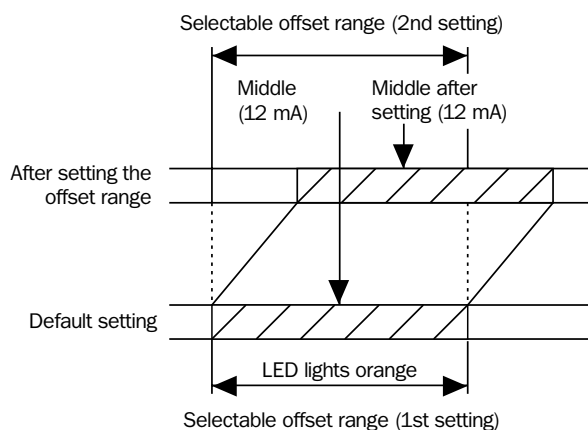

▼ 1. Position of the sensor

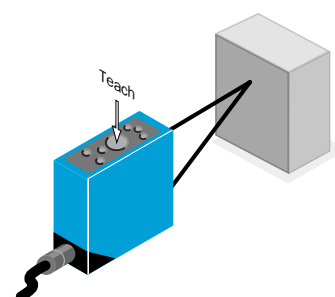
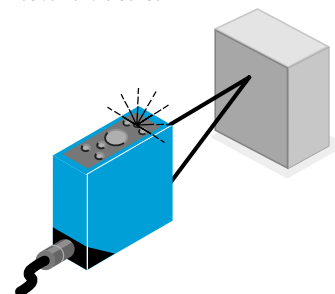

▲ 2. Teach-in calibration of the analog output

Two steps for resetting the offset

1. Switch the Mode selector to SET.
2. Press the Teach-in button longer than 5 seconds or trigger it via the connecting cable.

Three steps for setting the control output

1. Switch the Mode selector to SET. Position the object at the scanning distance 1. Press the Teach-in button for fewer than 2 seconds or trigger it via the connecting cable.
2. Position the object at the scanning distance 2. Press the Teach-in button for fewer than 2 seconds or trigger it via the connecting cable.
3. Switch the Mode selector to RUN or RUN with OFF DELAY.

The Teach-in input is independent of the position of the Mode selector.

* The hysteresis depends on the response time: the longer the response time, the smaller the hysteresis. The basic principle applies: the higher the reflectance, the smaller the hysteresis.

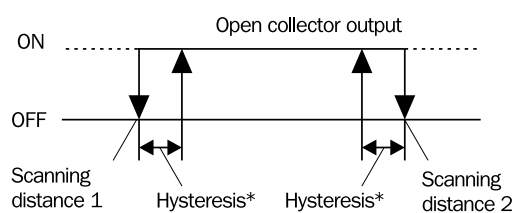

▼ Object in scanning distance 1

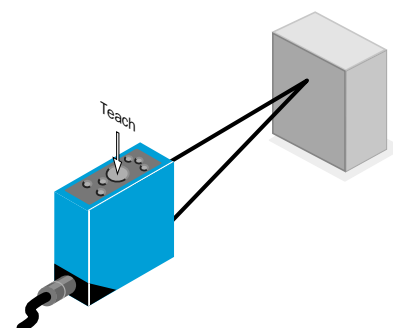
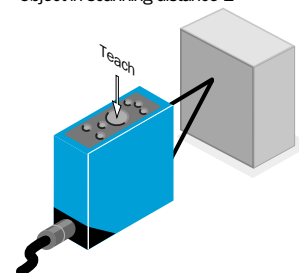

▲ Object in scanning distance 2

Displacement Sensors from the OD Series

Measuring range
 $25 \pm 5 / 50 \pm 10 \text{ mm}$

Displacement Sensor

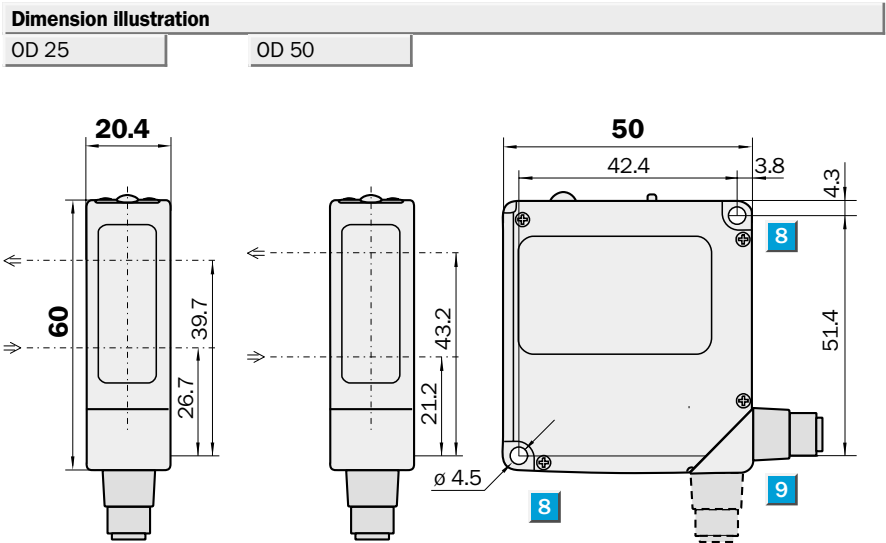

Setting options

| | |
|--------------|--------------|
| OD 25-05P132 | OD 50-10P142 |
| OD 25-05P830 | OD 50-10P840 |
| OD 25-05N132 | OD 50-10N142 |
| OD 25-05N830 | OD 50-10N840 |

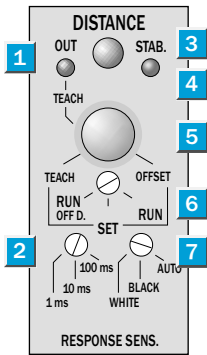

- 1 Teach-in indicator/output indicator
- 2 Response time selector
- 3 Distance indicator
- 4 Stable indicator
- 5 Teach-in button
- 6 Mode selector
- 7 Sensitivity selector
- 8 Mounting hole, $\varnothing 4.5$
- 9 Connecting cable 2 m (optional 5 m) or M 12 plug; 90° rotatable



Connection type

| | | | |
|--------------|--------------|--------------|--------------|
| OD 25-05P132 | OD 50-10P142 | OD 25-05P830 | OD 50-10P840 |
| OD 25-05N132 | OD 50-10N142 | OD 25-05N830 | OD 50-10N840 |

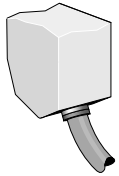

6 x 0.2 mm²

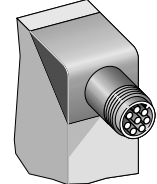
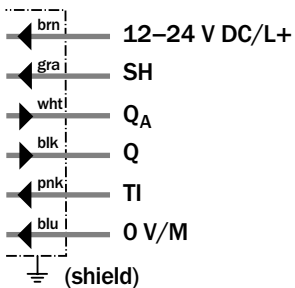

8-pin, M 12

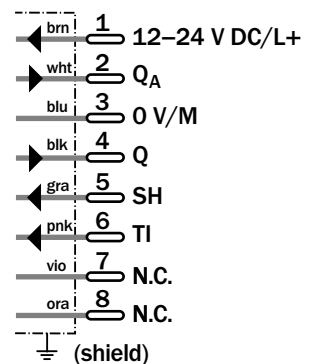

Accessories

| |
|-----------------------------|
| ODC evaluation unit |
| Cable receptacle with cable |

| Technical data | | OD | 25-05 P132 | 25-05 P830 | 25-05 N132 | 25-05 N830 | 50-10 P142 | 50-10 P840 | 50-10 N142 | 50-10 N840 | | |
|--|--|----|---------------|---------------|---------------|---------------|---------------|---------------|---------------|---------------|--|--|
| Measuring range | 25 ± 5 mm | | | | | | | | | | | |
| | 50 ± 10 mm | | | | | | | | | | | |
| Light source | LED, red light | | | | | | | | | | | |
| | Laser class 2 IEC 60825: 1998 | | | | | | | | | | | |
| Analog output | 4–20 mA, 0–300 Ω | | | | | | | | | | | |
| Control output ¹⁾ | PNP; 30 V/100 mA Open collector | | | | | | | | | | | |
| | NPN; 30 V/100 mA Open collector | | | | | | | | | | | |
| Accuracy | ±1 % FS ²⁾ /18 % – 90 %, ±4 % FS ²⁾ /6 % | | | | | | | | | | | |
| Linearity | ±1 % FS ²⁾ /18 % – 90 %, ±3 % FS ²⁾ /6 % | | | | | | | | | | | |
| Drift | ± 0.05 %/°C FS ²⁾ | | | | | | | | | | | |
| | ± 0.02 %/°C FS ²⁾ | | | | | | | | | | | |
| Resolution of analog output ³⁾ | 3/10/30 μm, 100/10/1 ms | | | | | | | | | | | |
| Hysteresis of control output | 10/30/100 μm (90 % remission) | | | | | | | | | | | |
| | 30/120/500 μm (6 % remission) | | | | | | | | | | | |
| Analog output freq. response – 3 dB | 100 ms – 6.7/s, 10 ms – 54/s, 1 ms – 770/s | | | | | | | | | | | |
| Teach-in input (TI) | NPN LOW = active, PNP HIGH = active | | | | | | | | | | | |
| Hold input (SH) | NPN LOW = active, PNP HIGH = active | | | | | | | | | | | |
| Timer | 40 ms off delay | | | | | | | | | | | |
| VDE protection class | III | | | | | | | | | | | |
| Sensitivity to ambient light | 10000 lx (sun), 3000 lx (artificial light) | | | | | | | | | | | |
| Supply voltage V_s | 12–24 V DC, –5%/+10 % | | | | | | | | | | | |
| Power consumption ⁴⁾ | 120 mA (at 24 V) | | | | | | | | | | | |
| Warmup time ⁵⁾ | 15 min maximum | | | | | | | | | | | |
| EMC | EN 50081-2, EN 50082-2 | | | | | | | | | | | |
| Enclosure rating | IP 67 | | | | | | | | | | | |
| Circuit protection ⁶⁾ | A, B, D | | | | | | | | | | | |
| Ambient temperature T_A ⁷⁾ | Operation: –10 ... +40 °C | | | | | | | | | | | |
| | Storage: –20 ... +60 °C | | | | | | | | | | | |
| Connection | Cable 2 m ⁸⁾ | | | | | | | | | | | |
| | Plug ⁹⁾ | | | | | | | | | | | |
| Housing | PBT (housing), Glass (window) | | | | | | | | | | | |
| | Zinc (housing), Glass (window) | | | | | | | | | | | |

¹⁾ Minimum teachable distance window is 4 ... 10 times resolution of analog output
²⁾ FS = Full Scale = 10 mm/OD25, 20 mm/OD50

³⁾ 90 % remission
⁴⁾ Without load
⁵⁾ For applications with the highest resolution and preciseness

⁶⁾ A = inputs and outputs reverse-polarity protected
 B = outputs protected against short-circuits
 D = pulse interference suppression

⁷⁾ Do not bend cable at temperatures lower than 0 °C
⁸⁾ Types with 5 m cables are available on request
⁹⁾ 2 m pre-fabricated cable, Order no. 6 020 663

Deviation OD 25-05 (LED)

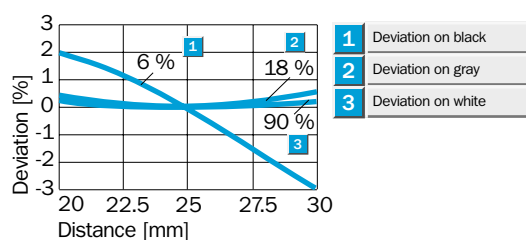

Deviation OD 50-10 (Laser)

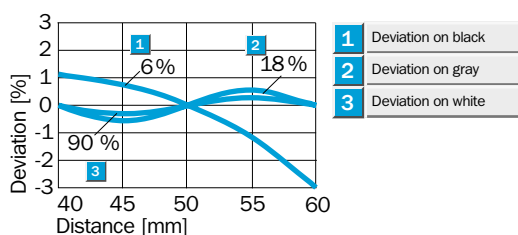

Ordering information

| Type | Order no. |
|--------------|-----------|
| OD 25-05P132 | 6 020 643 |
| OD 25-05P830 | 6 020 647 |
| OD 25-05N132 | 6 020 642 |
| OD 25-05N830 | 6 020 646 |
| OD 50-10P142 | 6 020 637 |
| OD 50-10P840 | 6 020 641 |
| OD 50-10N142 | 6 020 636 |
| OD 50-10N840 | 6 020 640 |

Light spot diameter OD 25-05 (LED)

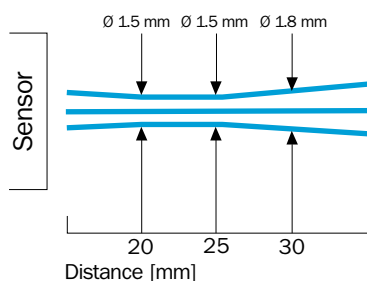

Light spot diameter OD 50-10 (Laser)

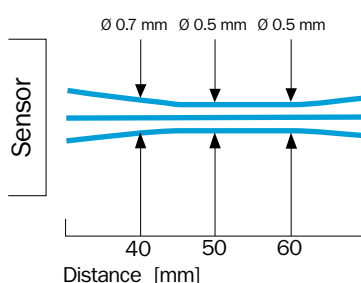

| | |
|----------------------------|-----------------------------|
| | Measuring ranges 30 ± 4 |
| | $100 \pm 35 / 130 \pm 50$ |
| | 250 ± 150 mm |
| Displacement Sensor | |

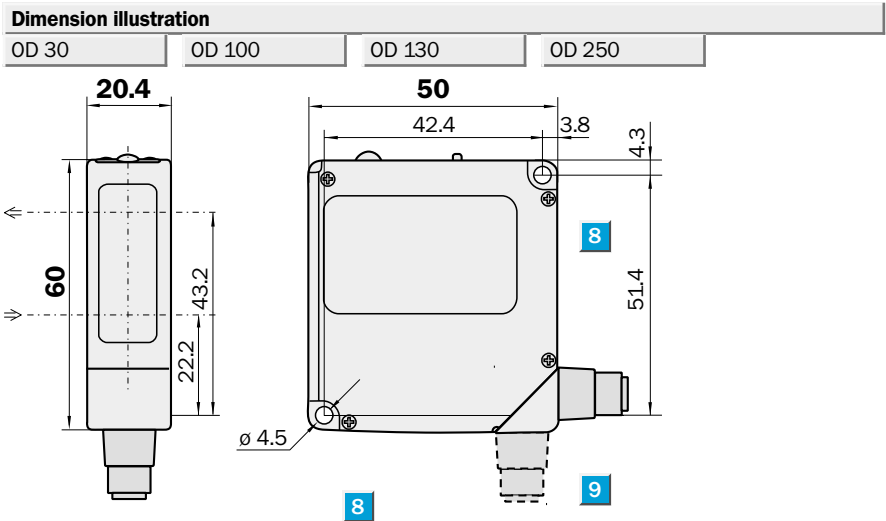

Setting options

| | |
|---------------|----------------|
| OD 30-04P142 | OD 130-50P142 |
| OD 30-04P840 | OD 130-50P840 |
| OD 30-04N142 | OD 130-50N142 |
| OD 30-04N840 | OD 130-50N840 |
| OD 100-35P142 | OD 250-150P142 |
| OD 100-35P840 | OD 250-150P840 |
| OD 100-35N142 | OD 250-150N142 |
| OD 100-35N840 | OD 250-150N840 |

- 1 Teach-in indicator/output indicator
- 2 Response time selector
- 3 Distance indicator
- 4 Stable indicator
- 5 Teach-in button
- 6 Mode selector
- 7 Sensitivity selector
- 8 Mounting hole, $\varnothing 4.5$ mm
- 9 Connecting cable 2 m (optional 5 m) or M 12 plug; 90° rotatable

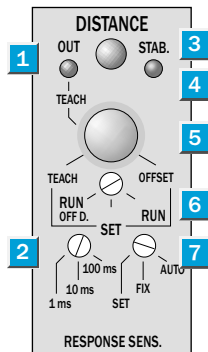

Connection type

| | | | |
|---------------|----------------|---------------|----------------|
| OD 30-04P142 | OD 130-50P142 | OD 30-04P840 | OD 130-50P840 |
| OD 30-04N142 | OD 130-50N142 | OD 30-04N840 | OD 130-50N840 |
| OD 100-35P142 | OD 250-150P142 | OD 100-35P840 | OD 250-150P840 |
| OD 100-35N142 | OD 250-150N142 | OD 100-35N840 | OD 250-150N840 |



Accessories

| |
|-----------------------------|
| ODC evaluation unit |
| Cable receptacle with cable |

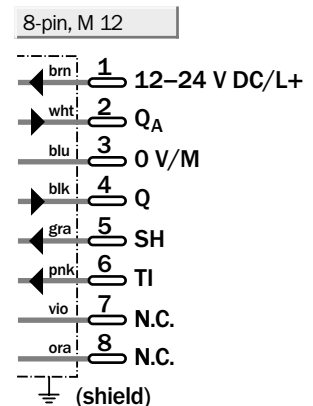
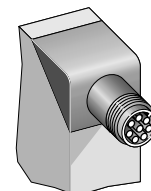
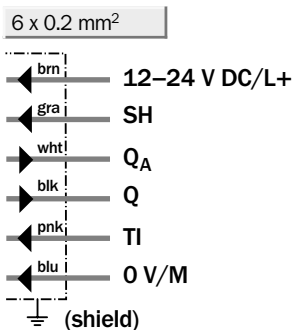
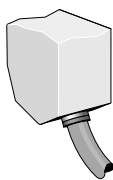

| Technical data | | OD | 30-04 | 30-04 | 100-35 | 100-35 | 130-50 | 130-50 | 250-150 | 250-150 |
|---|--|----|--------------------|--------------------|--------------------|--------------------|--------------------|--------------------|--------------------|--------------------|
| | | | P142 ¹⁾ | N142 ¹⁾ | P142 ¹⁾ | N142 ¹⁾ | P142 ¹⁾ | N142 ¹⁾ | P142 ¹⁾ | N142 ¹⁾ |
| | | | P840 ²⁾ | N840 ²⁾ | P840 ²⁾ | N840 ²⁾ | P840 ²⁾ | N840 ²⁾ | P840 ²⁾ | N840 ²⁾ |
| Measuring range | 30 mm ± 4 mm | | | | | | | | | |
| | 100 mm ± 35 mm | | | | | | | | | |
| | 130 mm ± 50 mm | | | | | | | | | |
| | 250 mm ± 150 mm | | | | | | | | | |
| Light source | Laser Klasse 2 IEC 60825: 1998 | | | | | | | | | |
| Analog output | 4–20 mA , 0–300 Ω | | | | | | | | | |
| Control output³⁾ | PNP; 30 V/100 mA Open collector | | | | | | | | | |
| | NPN; 30 V/100 mA Open collector | | | | | | | | | |
| Accuracy | ± 2% FS ⁴⁾ /90% – 6% | | | | | | | | | |
| | ± 3% FS ⁴⁾ /90% – 18% | | | | | | | | | |
| Linearity | ± 0,5% FS ⁴⁾ /90% – 6% | | | | | | | | | |
| | ± 1,5% FS ⁴⁾ /90% – 6% | | | | | | | | | |
| | ± 3% FS ⁴⁾ /90% – 18% | | | | | | | | | |
| Drift | ± 0,02%/°C FS ⁴⁾ | | | | | | | | | |
| Resolution of analog output ⁵⁾ | 10/3/1 μm, 1/10/100 ms | | | | | | | | | |
| | 150/50/15 μm, 1/10/100 ms | | | | | | | | | |
| | 200/70/20 μm, 1/10/100 ms | | | | | | | | | |
| | 1500/500/150 μm, 1/10/100 ms | | | | | | | | | |
| Analog output freq. response – 3 dB | 100 ms – 5/s, 10 ms – 42/s, 1 ms – 720/s | | | | | | | | | |
| Teach-in input (TI) | NPN LOW = active, PNP HIGH = active | | | | | | | | | |
| Hold input (SH) | NPN LOW = active, PNP HIGH = active | | | | | | | | | |
| Timer | 40 ms off delay | | | | | | | | | |
| VDE protection class | III | | | | | | | | | |
| Sensitivity to ambient light | 10000 lx (sun), 3000 lx (artificial light) | | | | | | | | | |
| Supply voltage V_s | 12–24 V DC, –5%/+10% | | | | | | | | | |
| Power consumption ⁶⁾ | 75 mA (at 24 V) | | | | | | | | | |
| Warmup time⁷⁾ | 10 min. maximum | | | | | | | | | |
| EMC | EN 50081-2, EN 50082-2 | | | | | | | | | |
| Enclosure rating | IP 67 | | | | | | | | | |
| Circuit protection⁸⁾ | A, B, D | | | | | | | | | |
| Ambient temperature T_A⁹⁾ | Operation: –10 ... +40 °C | | | | | | | | | |
| | Storage: –20 ... +60 °C | | | | | | | | | |
| Housing | PBT (housing), Glass (window) | | | | | | | | | |

¹⁾ Connection: cable 2 m
²⁾ Connection: Plug 2 m pre-fabricated cable, Order no. 6 020 663,
³⁾ Minimum teachable distance window is 4 ... 10 times resolution of analog output

⁴⁾ FS = Full Scale = 8 mm/OD 30, 80 mm/OD 100, 100 mm/OD 130, 300 mm/OD 250
⁵⁾ 90 % remission
⁶⁾ Without load

⁷⁾ For applications with the highest resolution and preciseness
⁸⁾ A = inputs and outputs reverse-polarity protected

B = outputs protected against short-circuits
 D = pulse interference suppression
⁹⁾ Do not bend cable at temperatures lower than 0 °C

OD 30-04: Deviation/lightspot diameter

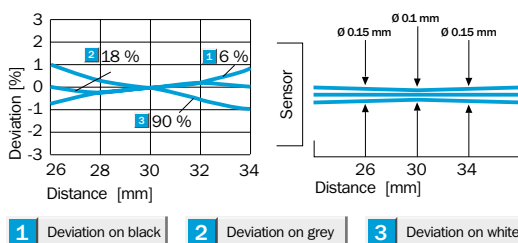

1 Deviation on black 2 Deviation on grey 3 Deviation on white

OD 100-35: Deviation/lightspot diameter

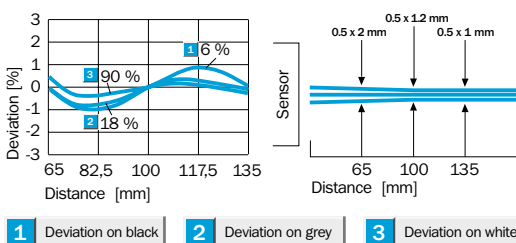

1 Deviation on black 2 Deviation on grey 3 Deviation on white

OD 130-50: Deviation/lightspot diameter

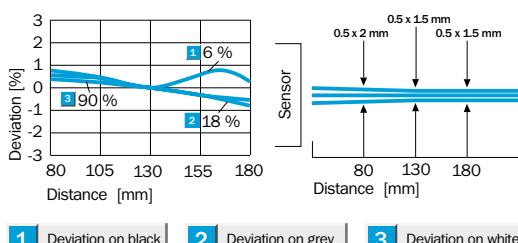

1 Deviation on black 2 Deviation on grey 3 Deviation on white

OD 250-150: Deviation/lightspot diameter

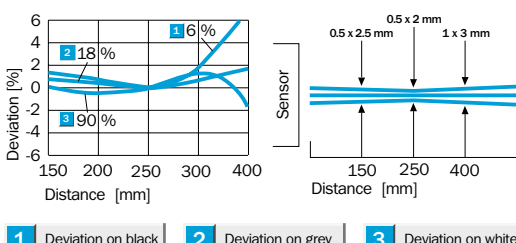

1 Deviation on black 2 Deviation on grey 3 Deviation on white

Ordering information

| Type | Order no. |
|----------------|-----------|
| OD 30-04P142 | 6 021 839 |
| OD 30-04P840 | 6 021 841 |
| OD 30-04N142 | 6 021 840 |
| OD 30-04N840 | 6 021 842 |
| OD 100-35P142 | 6 022 476 |
| OD 100-35P840 | 6 022 478 |
| OD 100-35N142 | 6 022 477 |
| OD 100-35N840 | 6 022 479 |
| OD 130-50P142 | 6 021 847 |
| OD 130-50P840 | 6 021 849 |
| OD 130-50N142 | 6 021 848 |
| OD 130-50N840 | 6 021 850 |
| OD 250-150P142 | 6 021 851 |
| OD 250-150P840 | 6 021 853 |
| OD 250-150N142 | 6 021 852 |
| OD 250-150N840 | 6 021 854 |

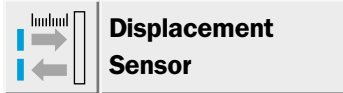

Industrial application possibilities for decentral automation



The ODC evaluation unit expands the functions of the displacement sensors in the OD series: Decentral automation with additional computing and processing functions.

An integrated Profibus-DP interface enables the simplest connection to superordinate controls.

Thickness can be determined directly with a combination of two OD displacement sensors and an ODC evaluation unit.

“Peak-(Bottom-)Hold”, “Peak-to-Peak”, “Sample-and-Hold”, and “Automatic peak and bottom value holds” and additional filter functions are features that are available when the displacement sensors of the OD series are supplemented with the ODC evaluation unit.

The selection of the respective functions is done easily using a keyboard on the clearly structured display.

Supplemented with the mounting socket ODC-SOC (available as accessory), installation is fast and provides additional advantages: Replacement of the ODC evaluation unit without loosening the connections to terminals; possibility to fit the ODC evaluation unit at a later date to avoid damages during the installation phase.

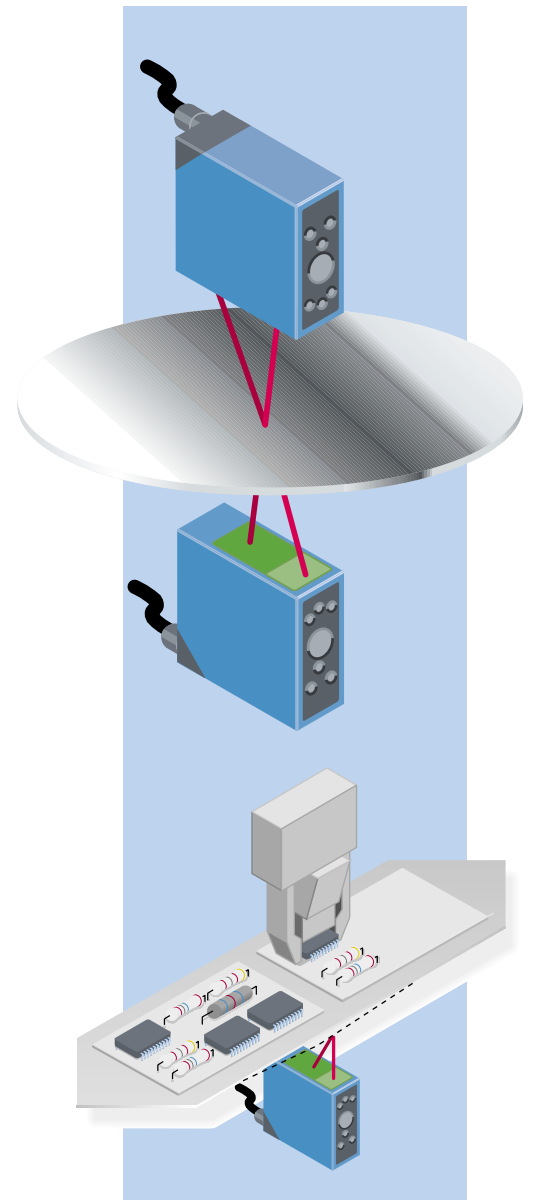

▲ **Semiconductor industry:** Thickness check and determination of wafers and ceramic substrates. The highly precise measurement is not influenced by reflecting scattered light. During assembly of boards, precise positioning is a must.

► **Automobile industry:** Tolerance checks of cams and crankshaft bearings with two or more OD displacement sensors and the ODC control equipment in an engine factory. The measured dimensions are even shown reliably in the μm range as absolute values on the ODC and transmitted per Profibus to the control. Determination of board strengths of almost all normally used materials and control of coating facilities are typical applications.

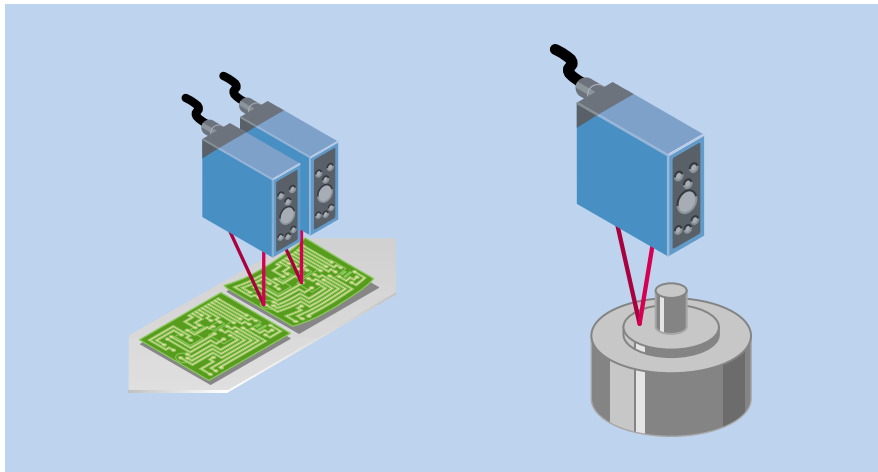
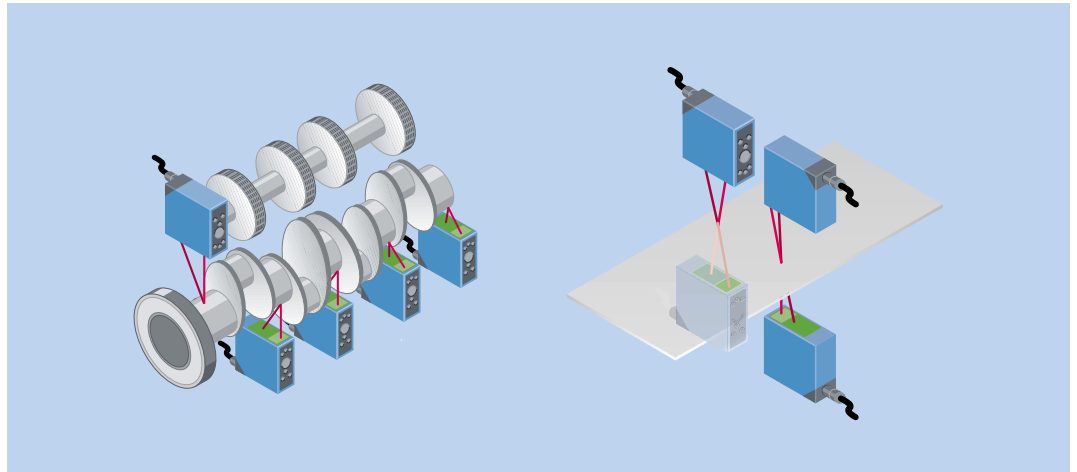

◀ **Electronics industry:** Checking the sagging of boards with a measurement arrangement consisting of two displacement sensors with an ODC control device in a motherboard design or assembly. Checking micrometer components in tape recorders, walkmans, CD players or memory drives. Low-reflection surfaces do not affect reliable measuring.

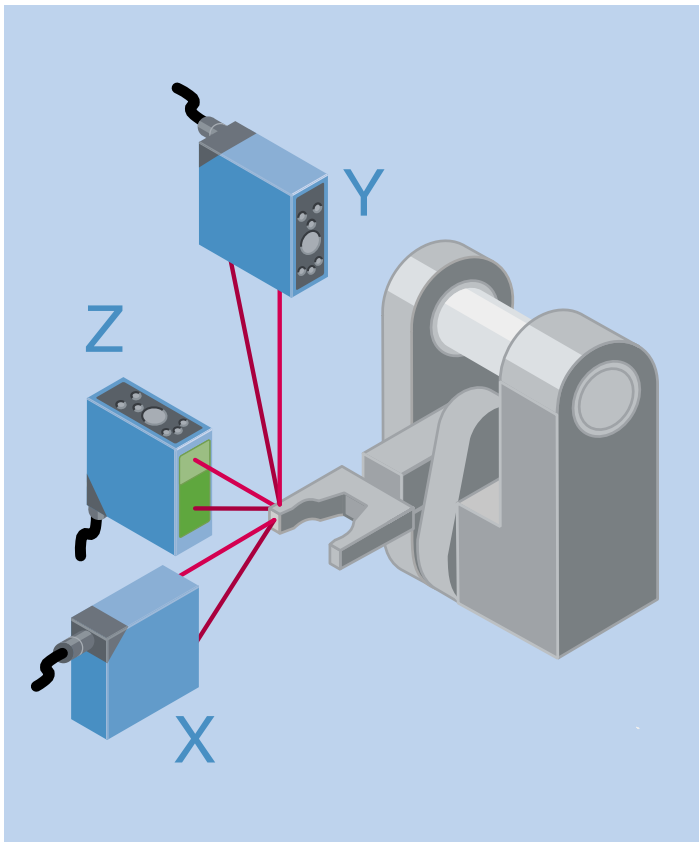

▲ **Robotics:** Zero point calibration and positioning control of robot arms in production lines with the OD displacement sensor and the ODC control unit. A closed loop control of the robot can be created via Profibus.

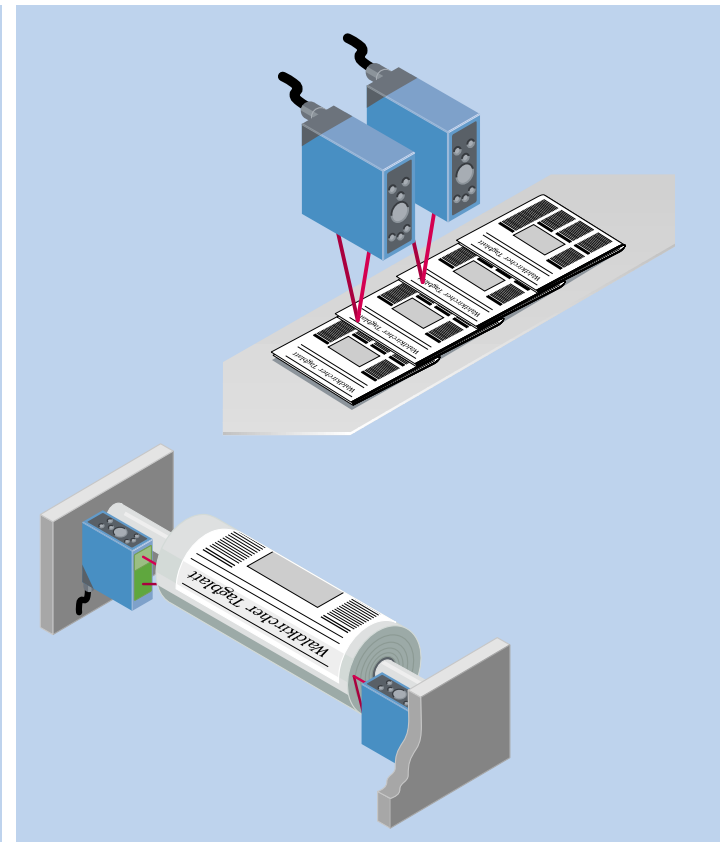

▲ **Paper and packaging industry:** Checking and counting newspaper or (thin) brochures after the folding process. Checking centering of paper-guiding axes and rollers in a printing plant.

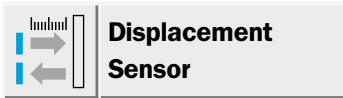

- Advanced digital signal processing
- Measuring value processing for difficult applications
- RS 232 and Profibus

Dimension illustration

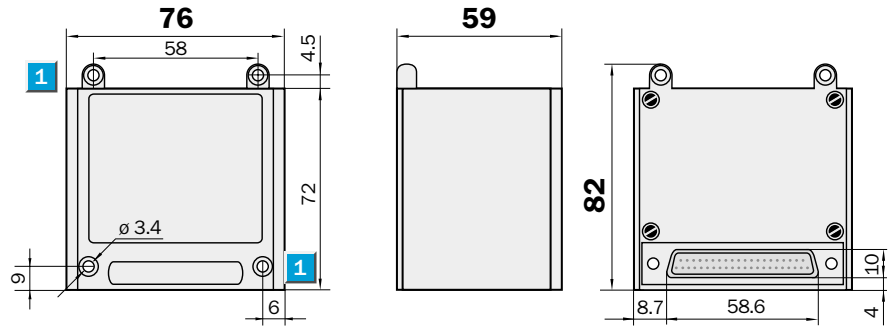

Setting options

ODC 100-P120

- 1 Mounting hole, \varnothing 3,4 mm
- 2 Electronics module
- 3 LC Display
- 4 Status LEDs
- 5 Film keyboard

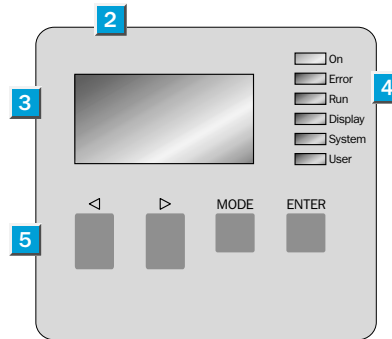

Connection type 37-pin, Sub D connector

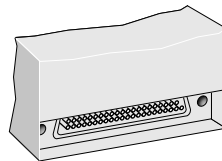

Accessories

| |
|--|
| Mounting socket ODC-SOC |
| Extension cable ODC \leftrightarrow ODC-SOC, 37-pin, Sub D female and male connector |
| ODC-IM-021 (1 m) 6 021 803 |
| ODC-IM-022 (2 m) 6 021 804 |
| ODC-IM-023 (3 m) 6 021 805 |

| | | |
|---------------------------------|----------------------------------|----------------------|
| 1 +24 V/L+ | 13 RTS | 25 Q 1 |
| 2 PE | 14 TxD | 26 Sync |
| 3 In-Sig. 2 - (GND) | 15 +24 V/L+ | 27 Teach sen. 1 (TI) |
| 4 In-Sig. 2 + (Q _A) | 16 PE | 28 Hold sen. 1 (SH) |
| 5 Shield 2 | 17 PE | 29 HH |
| 6 Q 2 | 18 +5 V | 30 LL |
| 7 Autozero | 19 PB + | 31 Go |
| 8 Teach sen. 2 (TI) | 20 GND/M | 32 CTS |
| 9 Hold sen. 2 (SH) | 21 PE | 33 RxD |
| 10 H | 22 In-Sig. 1 - (GND) | 34 GND/M |
| 11 L | 23 In-Sig. 1 + (Q _A) | 35 PE |
| 12 Error | 24 Shield 1 | 36 GND/M |
| | | 37 PB - |

| Technical data | | ODC 100 | -P120 | | | | | | | | | | |
|--------------------------------------|---|---------|-------|--|--|--|--|--|--|--|--|--|--|
| Analog inputs | Two inputs, 0 ... 20 mA (can be selected according to device type) | | | | | | | | | | | | |
| Accuracy | ± 0.05 % (Full Scale) | | | | | | | | | | | | |
| Scanning frequency | 2 kHz max. | | | | | | | | | | | | |
| Measuring value calculation | Linearization, Offset, Autozero Scaling A, B, A + B, A – B, K – (A + B) ¹⁾ | | | | | | | | | | | | |
| Measurement function | Peak/Bottom/Hold, Peak-to-Peak-Hold, Sample/Hold, Autom. Peak Hold | | | | | | | | | | | | |
| Filter functions | HIGH-pass, LOW-pass, Averaging | | | | | | | | | | | | |
| Interfaces | RS 232 Profibus DP | | | | | | | | | | | | |
| Control outputs ²⁾ | PNP; 30 V/100 mA Open collector | | | | | | | | | | | | |
| Outputs | HH, H, Go, L, LL and PNP (can be selected according to device type) Error | | | | | | | | | | | | |
| Inputs | Sync, Autozero | | | | | | | | | | | | |
| Off delay | 60 ms fixed for the outputs | | | | | | | | | | | | |
| Supply voltage V_s | 24 V DC ± 10 % | | | | | | | | | | | | |
| EMC | EN 50081-1, EN 50082-2 | | | | | | | | | | | | |
| VDE protection class | III | | | | | | | | | | | | |
| Enclosure rating | IP 20 | | | | | | | | | | | | |
| Ambient temperature | Operation: 0 ... +40 °C Storage: –30 ... +60 °C | | | | | | | | | | | | |
| Housing material | Zinc | | | | | | | | | | | | |

¹⁾ A = Sensor 1
B = Sensor 2

²⁾ Total current of all outputs < 500 mA

Technical features

High-pass filter

Function: Elimination of the low-frequency components of the analog input signal.
Effect: Gradual signal changes are ignored, i.e., only fast changes are recorded.

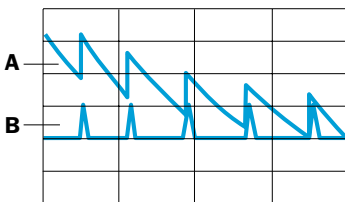

A Non-filtered data: Height difference and height are displayed.
B Filtered data: Only the height difference is displayed.

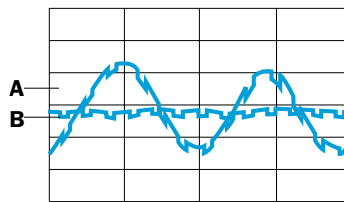

A Non-filtered data: Number of grooves and the eccentricity are displayed.
B Filtered data: Only the number is displayed.

Ordering information

| Type | Order no. |
|--------------|-----------|
| ODC 100-P120 | 6 022 480 |

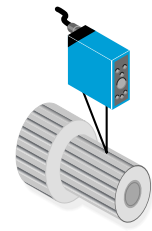

Measuring the groove depth or numbers of grooves

Low-pass filter

Function: Elimination of the high-frequency components of the analog input signal.
Effect: Fast signal changes are ignored, i.e., only gradual changes are recorded.

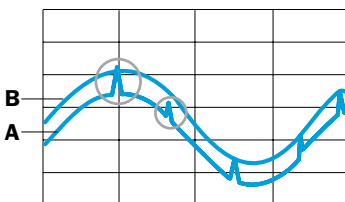

A Non-filtered data: Interferences are displayed.
B Filtered data: Measurement curve is displayed without interferences.

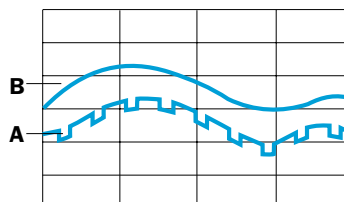

A Non-filtered data: Grooves and eccentricity are displayed.
B Filtered data: Only the eccentricity is displayed.

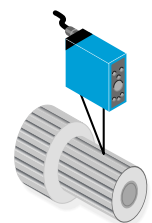

Measurement whether the collector runs round

Time behavior graphs

Peak-Bottom-Hold

The “Peak-(Bottom)-Hold” function is used for measuring the highest (lowest) value during a specific time period.

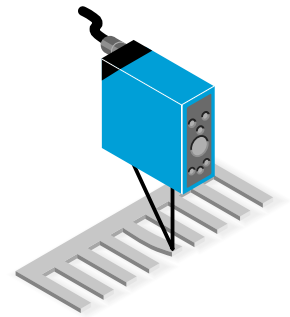
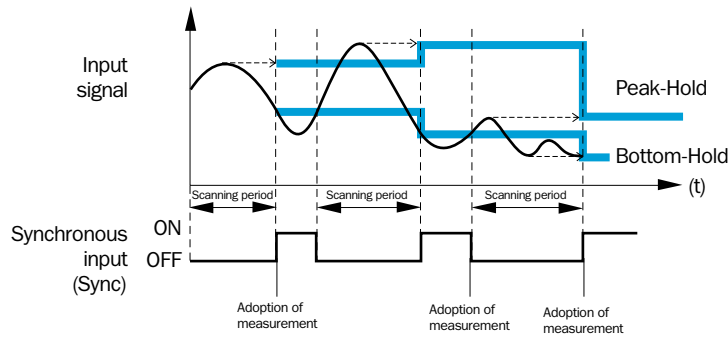

Peak-to-Peak-Hold

The “Peak-to-Peak” function is used for measuring the difference between the highest and lowest values during the preset time period.

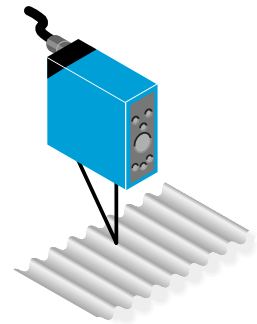
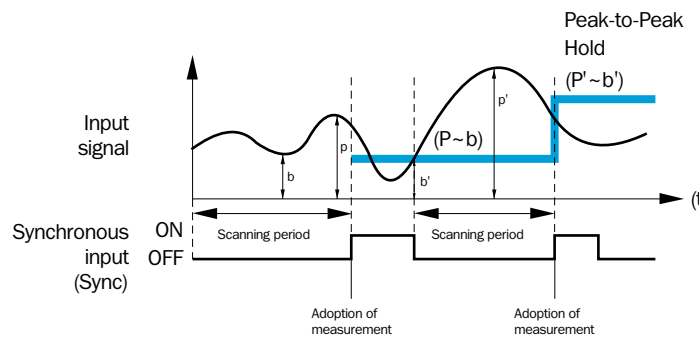

Sample/Hold

The “Sample-and-Hold” function is used for measuring the value during a specific time period.

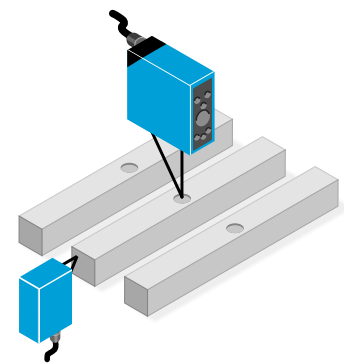
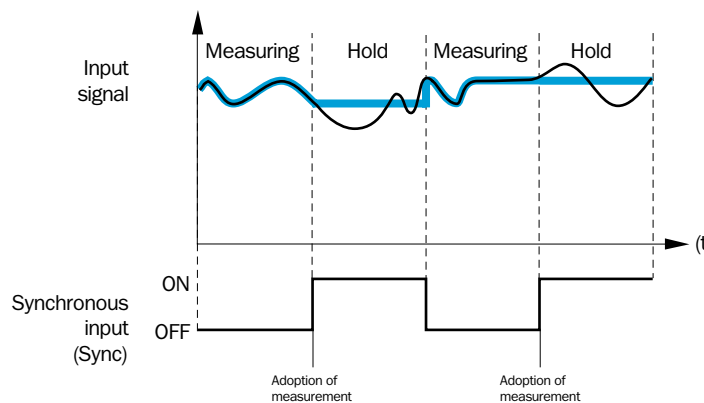

Automatic Peak-Bottom-Hold

The “Automatic Peak- and Bottom-Hold” function is used for measuring the highest (lowest) value from the beginning of the measurement.

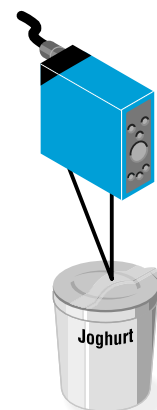
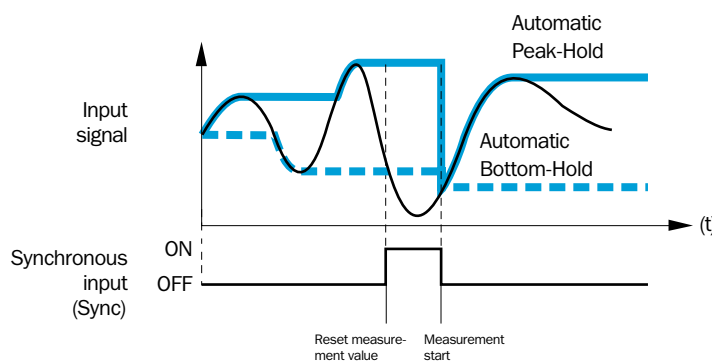



- ODC-SOC:
Mounting socket for tophat profile rail mounting

Dimension illustration mounting socket ODC-SOC

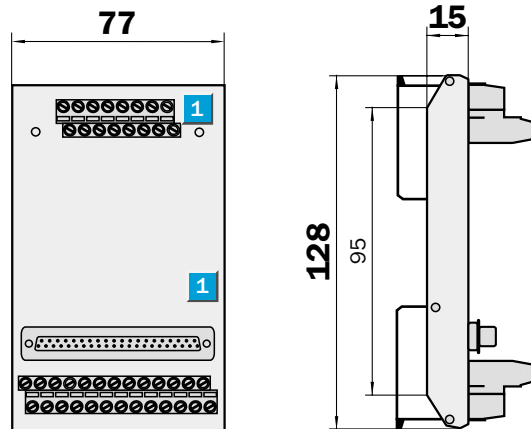

Connection option

- 1 Taphole for screwing the ODC evaluation unit, M 3



Terminal assignment X1

X1, Module not connected to the end of the field bus cable

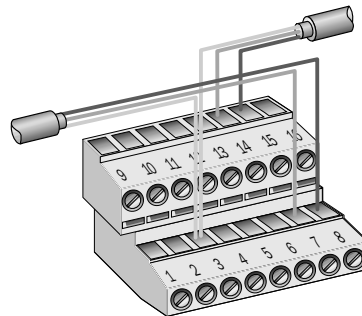

X1, Module connected to the end of the field bus cable

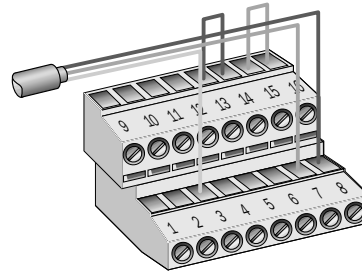

| | |
|----|----------|
| 1 | GND/M |
| 2 | GND/M |
| 3 | PE |
| 4 | GND |
| 5 | TxD |
| 6 | RxD |
| 7 | PB + |
| 8 | PB - |
| 9 | +24 V/L+ |
| 10 | +24 V/L+ |
| 11 | RTS |
| 12 | CTS |
| 13 | +5 V |
| 14 | PB + |
| 15 | PB - |
| 16 | GND/M |

Ordering information

| Type | Order no. |
|---------|-----------|
| ODC-SOC | 6 020 985 |

Terminal assignment X2

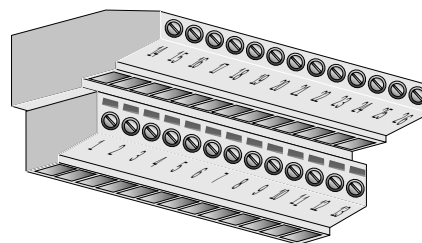

| | | | |
|----|------------------------------|----|------------------------------|
| 1 | +24 V/L+ | 14 | +24 V/L+ |
| 2 | GND/M (0 V) | 15 | GND/M (0 V) |
| 3 | In-Sig. 1- (GND) | 16 | In-Sig. 2- (GND) |
| 4 | In-Sig. 1+ (Q _A) | 17 | In-Sig. 2+ (Q _A) |
| 5 | Shield 1 | 18 | Shield 2 |
| 6 | Q 1 | 19 | Q 2 |
| 7 | Sync | 20 | Autozero |
| 8 | Teach sen. 1 (TI) | 21 | Teach sen. 2 (TI) |
| 9 | Hold sen. 1 (SH) | 22 | Hold sen. 2 (SH) |
| 10 | HH | 23 | H |
| 11 | LL | 24 | L |
| 12 | Go | 25 | Error |
| 13 | GND/M | 26 | +24 V/L+ |

Your contact:

Australia

Phone +61 3 94 97 41 00
0 08 33 48 02 – toll free
Fax +61 3 94 97 11 87

Austria

Phone +43 2 23 66 22 88-0
Fax +43 2 23 66 22 88-5

Belgium/Luxembourg

Phone +32 24 66 55 66
Fax +32 24 63 35 07

Brazil

Phone +55 11 55 61 26 83
Fax +55 11 55 35 41 53

China/Hong Kong

Phone +8 52 27 63 69 66
Fax +8 52 27 63 63 11

Czech Republic

Phone +42 02 578 10 561
Fax +42 02 578 10 559

Denmark

Phone +45 45 82 64 00
Fax +45 45 82 64 01

Finland

Phone +3 58 9-7 28 85 00
Fax +3 58 9-72 88 50 55

France

Phone +33 1-64 62 35 00
Fax +33 1-64 62 35 77

Germany

Phone +49 2 11 53 01-0
Fax +49 2 11 53 01-1 00

Great Britain

Phone +44 17 27-83 11 21
Fax +44 17 27-85 67 67

Italy

Phone +39 02-92 14 20 62
Fax +39 02-92 14 20 67

Japan

Phone +813 33 58-13 41
Fax +813 33 58-05 86

Netherlands

Phone +31 3 02 29 25 44
Fax +31 3 02 29 39 94

Norway

Phone +47 67 81 50-0
Fax +47 67 81 50-01

Poland

Phone +48 22 8 37 40 50
Fax +48 22 8 37 43 88

Singapore

Phone +65 7 44 37 32
Fax +65 8 41 77 47

Spain

Phone +34 9 34 80 31 00
Fax +34 9 34 73 44 69

Sweden

Phone +46 8-6 80 64 50
Fax +46 8-7 10 18 75

Switzerland

Phone +41 4 16 19 29 39
Fax +41 4 16 19 29 21

Taiwan

Phone +88 62 23 65 62 92
Fax +88 62 23 68 73 97

USA

Phone +1 (952) 9 41-67 80
Fax +1 (952) 9 41-92 87

Representatives and agencies
in all major industrial nations.

The SICK logo consists of the word "SICK" in a bold, blue, sans-serif font. The letters are closely spaced and have a slight shadow effect.

SICK AG • Automatisierungstechnik • Sebastian-Kneipp-Straße 1 • D-79183 Waldkirch
Phone +49 76 81 2 02-0 • Fax +49 76 81 2 02-36 09 • www.sick.de