



# W 260: Standard photoelectric switch series for a broad range of applications

	<b>Photoelectric proximity switches, BGS</b>
	<b>Photoelectric proximity switches, energetic</b>
	<b>Photoelectric reflex switches</b>





- universal voltage 12...24 V DC and 24...240 V AC with potential-free relay contact (SPDT) or, alternatively, adjustable time delay.

A variety of features make these sensors particularly operator-friendly. These include visible red transmitted light used as an alignment aid, or the simple and flexible connection system, glass/stainless steel fibre-optic cables for harsh operating conditions in confined environments. All of these benefits open up applications far beyond handling/warehousing systems, the packaging industry and wood working. All device variants have been granted UL and CSA approval.

The W 260 series with its impressive scanning ranges and features has been specially designed for a wide variety of different applications. The sensors, through-beam photoelectric switches, energetic photoelectric proximity switches, and photoelectric reflex switches with background suppression are contained in robust plastic housings. Handling is simple and user-friendly. Two supply voltages are available:

- low voltage 10...30 V DC with PNP or NPN transistor switching output and test input and

One last highlight: the W 260 complies with EN 50081-1 (interference radiation). This makes it the perfect sensor solution for door and gate control systems in underground garages and for use in residential blocks or hotels.

	<b>Through-beam photoelectric switches</b>
	<b>Photoelectric switches with fibre-optic cable</b>
<b>Proximity mode</b>	
	<b>Photoelectric switches with fibre-optic cable</b>
<b>Through-beam mode</b>	

► WS/WE 260 through-beam photoelectric switches and WT 260 photoelectric proximity switches used for monitoring contours in palletisation systems to ensure that no problems are encountered during packaging.

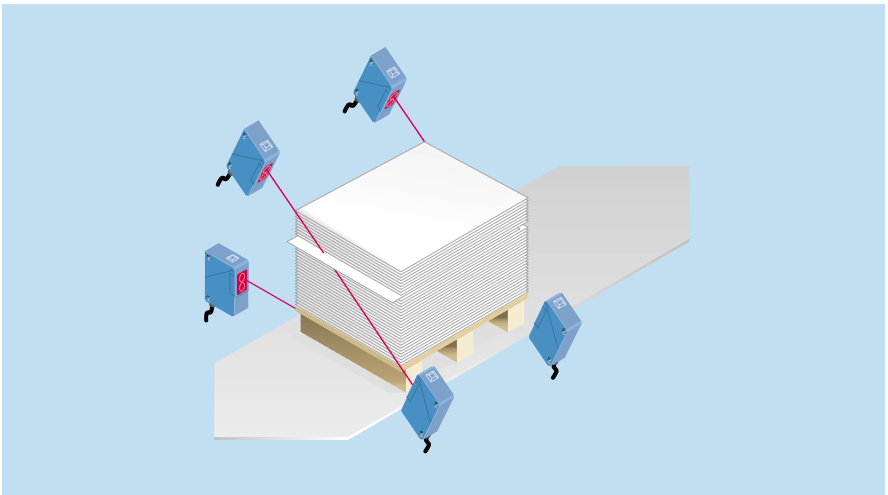

▼ A WT 260 photoelectric proximity switch controlling a commissioning system used in the wood-working industry.



▲ CE conformity to EN 50081-1 and, therefore, the right choice for residential and commercial applications: the WL 260 photoelectric reflex switch used to monitor the closing edges in automatic door and gate systems.

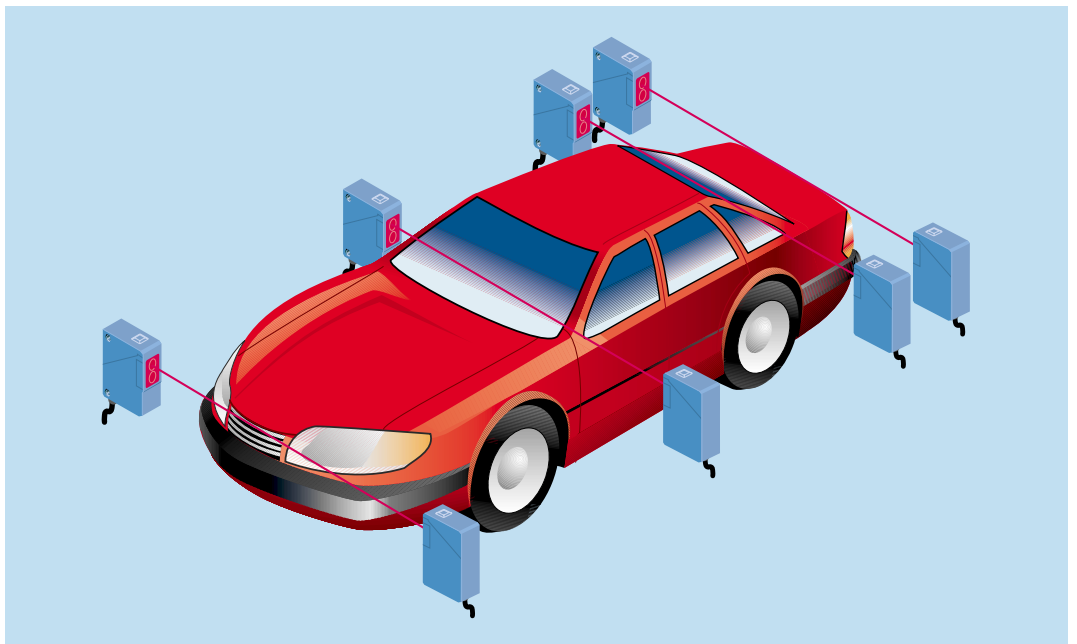

▲ WS/WE 260 through-beam photoelectric switches used for detecting the outline of vehicle bodies on assembly lines in the automotive industry.

**Scanning distance**  
0...380 mm

Photoelectric proximity switches

- Reliable detection of dark objects even against light backgrounds
- Scanning distance continuously adjustable
- Terminal chamber or M 12 plug, 4-pin or 5-pin
- Test input
- Pre-failure signalling output

**Dimensional drawing**

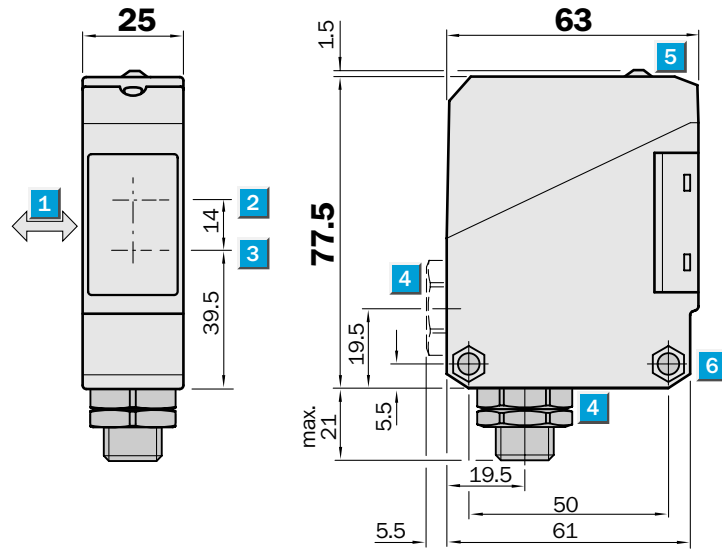

**Adjustments possible**

- WT 260-P 260
- WT 260-P 460
- WT 260-P 560

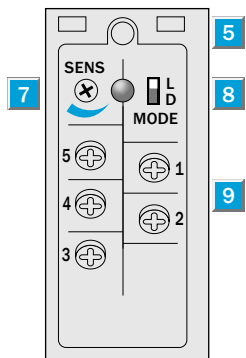

- 1 Standard direction of material being scanned
- 2 Centre of optical axis, receiver
- 3 Centre of optical axis, sender
- 4 Cable entry gland 1/2" PF thread for cable diameters from 6 to 10 mm optionally at bottom or rear; or M 12 equipment plug bottom
- 5 LED signal strength indicator, red
- 6 Through hole  $\varnothing$  5.2 mm on both sides for M 5 hex nut
- 7 Scanning distance adjustment
- 8 Light-/dark-switching (L = light-switching, D = dark-switching)
- 9 Terminals

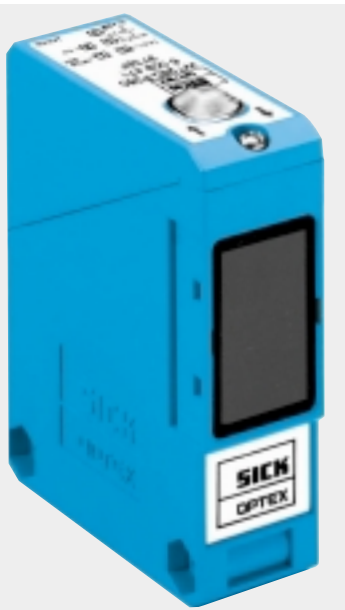

**Connection types**

- WT 260-P 260
- WT 260-P 460
- WT 260-P 560

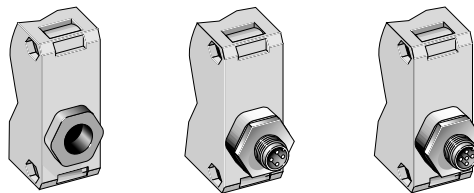

**Terminals**

**4-pin, M 12**

**5-pin, M 12**

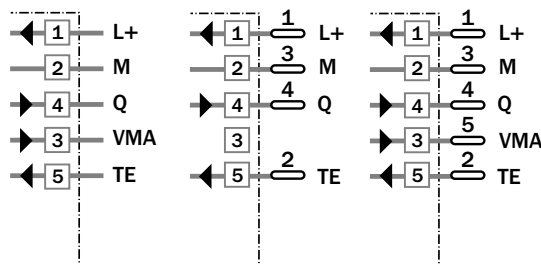

Accessories	page
Cable receptacles M 12	496
Mounting brackets*	510

\* included with delivery

Technical data		WT 260-	P 260	P 460	P 560
<b>Scanning distance</b>	Max.: 0...380 mm, adjustable <sup>1)</sup>				
	Min.: 75...160 mm, adjustable <sup>1)</sup>				
	Adjustable, potentiometer 270°				
<b>Light source<sup>2)</sup>, light type</b>		LED, infrared light			
Light spot diameter	Approx. 17 mm at 300 mm				
Aperture angle sender	Approx. 1.5°				
<b>Supply voltage V<sub>s</sub></b>		10...30 V DC <sup>3)</sup>			
Ripple <sup>4)</sup>	≤ 5 V <sub>SS</sub>				
Current consumption <sup>5)</sup>	≤ 35 mA				
<b>Switching outputs</b>		PNP, open collector: Q			
Output current I <sub>A</sub> max.	100 mA				
Light receiver, switching mode	Light-/dark-switching by sliding switch				
Response time <sup>6)</sup>	≤ 2 ms				
Max. switching frequency <sup>7)</sup>	250/s				
Pre-failure signalling output VMA <sup>8)</sup>	100 mA, static				
<b>Test input "TE" sender off</b>		PNP: TE to + V <sub>s</sub>			
<b>Connection types</b>		Terminal chamber			
	Plug M 12, 4-pin				
	Plug M 12, 5-pin				
<b>VDE protection class<sup>9)</sup></b>		□			
<b>Circuit protection<sup>10)</sup></b>		A, B, C, D			
<b>Enclosure rating</b>		IP 66			
<b>Ambient temperature T<sub>A</sub></b>		Operation - 25 °C...+ 55 °C			
	Storage - 40 °C...+ 70 °C				
<b>Weight</b>		Approx. 120 g			
<b>Material</b>		Housing: ABS; optics: PC			

- 1) Object with 90 % remission (based on standard white DIN 5033)
- 2) Average service life 100,000 h at T<sub>A</sub> = + 25 °C
- 3) Limit values
- 4) Must be within V<sub>s</sub> tolerances
- 5) Without load
- 6) With resistive load
- 7) With light/dark ratio 1:1
- 8) Operating reserve < 50 %
- 9) Reference voltage 50 V DC
- 10) A = V<sub>s</sub> connections reverse-polarity protected  
 B = Inputs/outputs reverse-polarity protected  
 C = Interference suppression  
 D = Outputs overcurrent and short-circuit protected
- 11) Black = 6 % remission  
 Grey = 18 % remission  
 White = 90 % remission

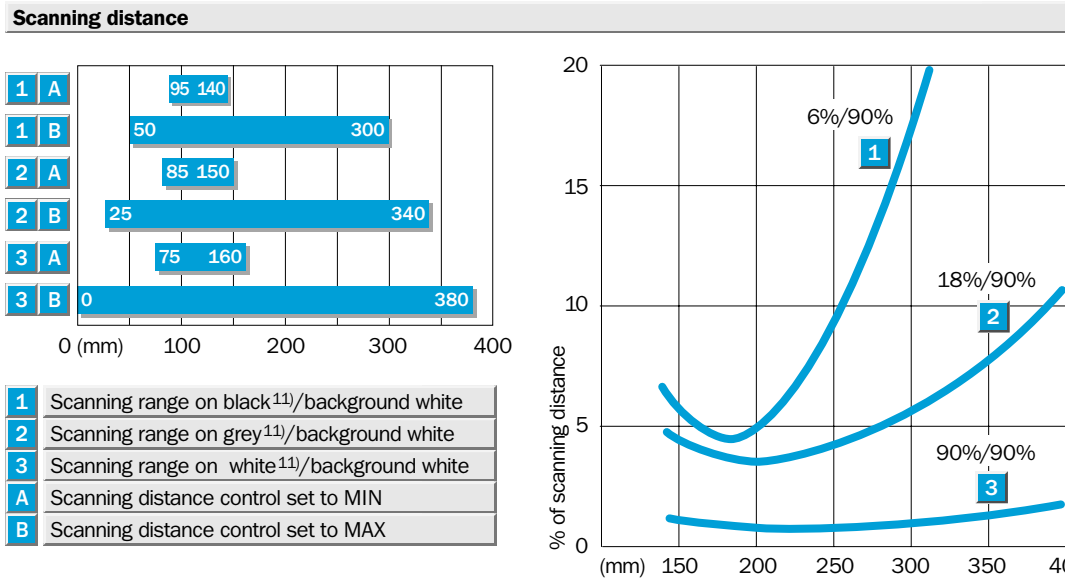

**Order information**

Type	Part no.
WT 260-P 260	6 009 471
WT 260-P 460	1 011 540
WT 260-P 560	1 011 541

**Scanning distance**  
0...380 mm

Photoelectric proximity switches

- Reliable detection of dark objects even against light backgrounds
- Scanning distance continuously adjustable
- Terminal chamber
- Universal current supply, relay output, SPST, timer optional

**Dimensional drawing**

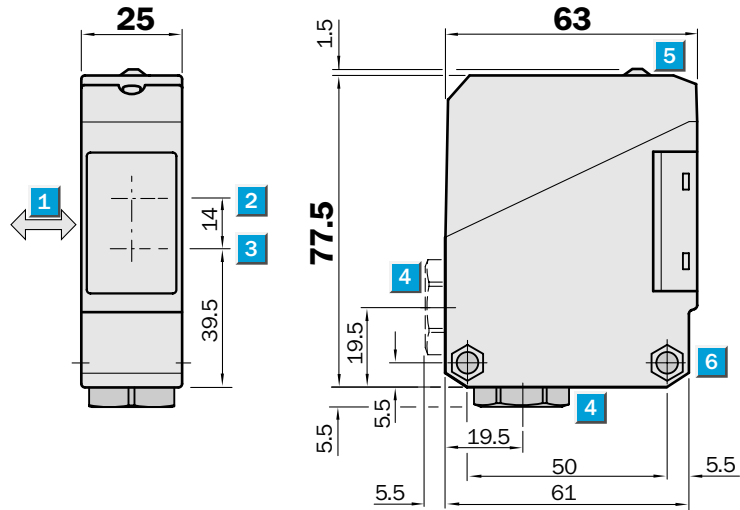

**Adjustments possible**

WT 260-S 260	WT 260-R 260
--------------	--------------

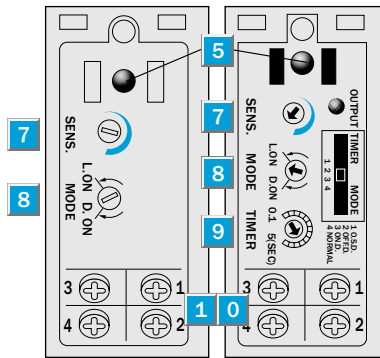

- 1 Standard direction of material being scanned
- 2 Centre of optical axis, receiver
- 3 Centre of optical axis, sender
- 4 Cable entry gland 1/2" PF thread for cable diameters from 6 to 10 mm optionally at bottom or rear
- 5 LED signal strength indicator, red
- 6 Through hole  $\varnothing$  5.2 mm on both sides for M 5 hex nut
- 7 Scanning distance adjustment
- 8 Light/dark rotary switch (L.ON = light-switching, D.ON = dark-switching)
- 9 Time range control
- 1 0 Terminals
- 1 1 Red LED status indicator; switching output active
- 1 2 Time delay selector switch  
O.S.D. = One Shot  
OFF.D. = OFF delay  
ON.D. = ON delay  
Normal = No delay



**Connection type**

WT 260-S 260
WT 260-R 260

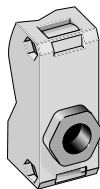

**Terminals**

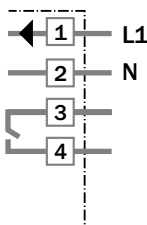

<b>Accessories</b>	page
Mounting brackets*	510

\* included with delivery

**Time delay**

$t = 0.1 - 5 \text{ s}$

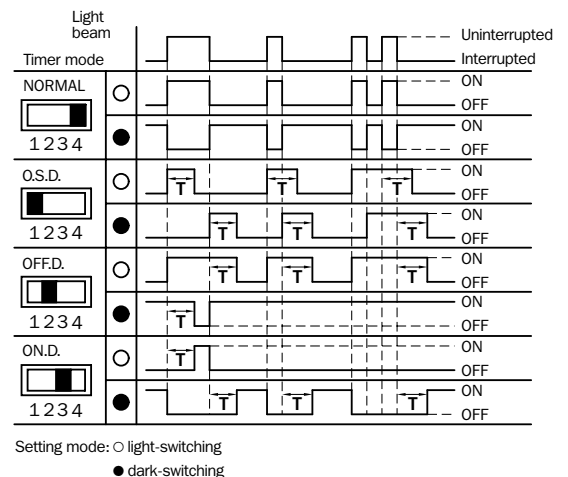

Technical data		WT 260-	S 260	R 260								
<b>Scanning distance</b>	Max.: 0...380 mm, adjustable <sup>1)</sup>											
	Min.: 75...160 mm, adjustable <sup>1)</sup>											
Scanning distance	Adjustable, potentiometer 270°											
<b>Light source<sup>2)</sup>, light type</b>	LED, infrared light											
Light spot diameter	Approx. 17 mm at 300 mm											
Angle of dispersion, sender	Approx. 1.5°											
<b>Supply voltage V<sub>s</sub><sup>3)</sup></b>	12...240 V DC											
	24...240 V AC											
Power consumption	≤ 5 VA											
<b>Switching outputs</b>	Relay, SPST, electrically isolated											
Switching current I <sub>A</sub> max. <sup>4)</sup>	3 A/240 V AC; 3 A/30 V DC											
Light receiver, switching mode	Light-/dark-switching by rotary switch											
Response time	≤ 20 ms											
Max. switching frequency <sup>5)</sup>	25/s											
<b>Time delay</b>	With LED display: switching output active											
Switch position:	«1 O.S.D.»	«One shot»										
	«2 OFF.D.»	OFF delay										
	«3 ON.D.»	ON delay										
	«4 Normal»	No delay										
<b>Delay</b>	Adjustable, 0.1...5 s; potentiom. 270°											
<b>Connection type</b>	Terminal chamber											
<b>VDE protection class<sup>6)</sup></b>	□											
<b>Circuit protection<sup>7)</sup></b>	A, C											
<b>Enclosure rating</b>	IP 66											
<b>Ambient temperature T<sub>A</sub></b>	Operation -25 °C...+55 °C											
	Storage -40 °C...+70 °C											
<b>Weight</b>	Approx. 120 g											
<b>Material</b>	Housing: ABS; optics: PC											

- 1) Object with 90 % remission (based on standard white DIN 5033)
- 2) Average service life 100,000 h at T<sub>A</sub> = +25 °C
- 3) ± 10 %
- 4) Provide suitable spark suppression for inductive or capacitive loads
- 5) With light/dark ratio 1:1
- 6) Reference voltage 250 V UC
- 7) A = V<sub>s</sub> connections reverse-polarity protected  
C = Interference suppression
- 8) Black = 6 % remission  
Grey = 18 % remission  
White = 90 % remission

Scanning distance		Order information	
		<b>Type</b>	<b>Part no.</b>
		WT 260-S 260	6 009 473
		WT 260-R 260	6 009 472

- 1 Scanning range on black<sup>8)</sup>/background white
- 2 Scanning range on grey<sup>8)</sup>/background white
- 3 Scanning range on white<sup>8)</sup>/background white
- A Scanning distance control set to MIN
- B Scanning distance control set to MAX

**Scanning distance**  
**10...3200 mm**

Photoelectric proximity switches

- Adjustable sensitivity
- Terminal chamber or M 12, 4-pin plug
- Test input

**Dimensional drawing**

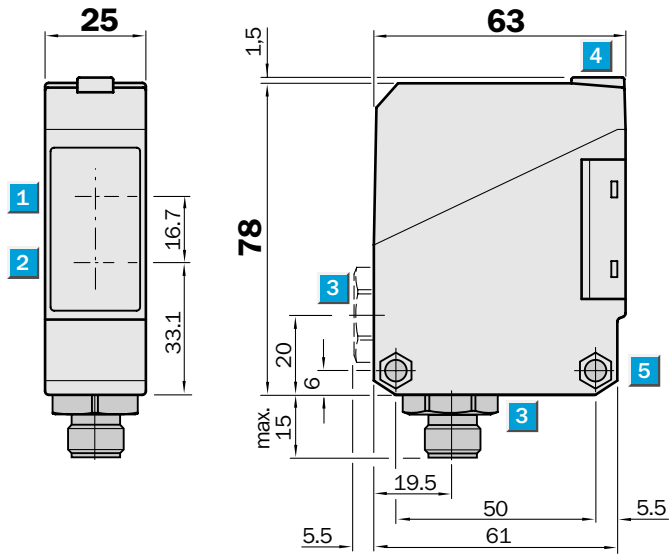

**Adjustments possible**

WT 260-F 280
WT 260-F 480
WT 260-E 280

- 1** Centre of optical axis, receiver
- 2** Centre of optical axis, sender
- 3** Cable entry gland 1/2" PF thread for cable diameters from 6 to 10 mm optionally at bottom or rear; or M 12 equipment plug, bottom
- 4** LED signal strength indicator, yellow, switching output active
- 5** Through hole  $\varnothing$  5.2 mm on both sides for M 5 hex nut
- 6** Sensitivity adjustment
- 7** Light/dark rotary switch  
L.ON = light-switching, D.ON = dark-switching
- 8** Terminals

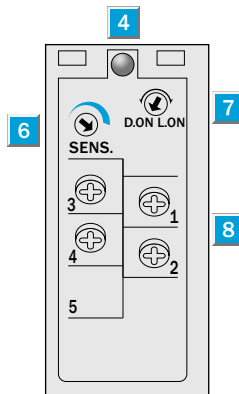

**Connection types**

WT 260-F 280	WT 260-F 480
WT 260-E 280	

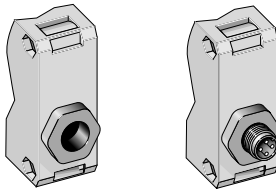

Terminals 4-pin, M 12

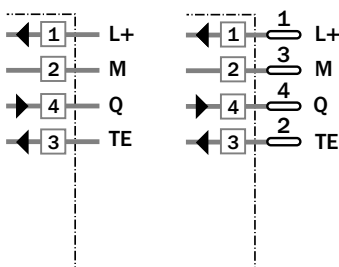

Accessories	page
Cable receptacles	496
Mounting brackets*	510

\* included with delivery

Technical data		WT 260-	F 280	F 480	E 280
<b>Scanning distance</b>	0...3200 mm, adjustable <sup>1)</sup>				
<b>Operating distance</b>	15...2500 mm, adjustable <sup>1)</sup>				
Sensitivity	Adjustable, potentiometer 270°				
<b>Light source<sup>2)</sup>, light type</b>	LED, infrared light				
Light spot diameter	Approx. 80 mm at 2500 mm				
Angle of dispersion, sender	Approx. 1.8°				
<b>Supply voltage <math>V_s</math></b>	10...30 V DC <sup>3)</sup>				
Ripple <sup>4)</sup>	$\leq 5 V_{SS}$				
Current consumption <sup>5)</sup>	$\leq 35$ mA				
<b>Switching outputs</b>	PNP, open collector: Q NPN, open collector: Q				
Output current $I_A$ max.	100 mA				
Light receiver, switching mode	Light-/dark-switching by rotary switch				
Response time <sup>6)</sup>	$\leq 5.0$ ms				
Max. switching frequency <sup>7)</sup>	100/s				
<b>Test input "TE" sender off</b>	PNP: TE to + $V_s$ NPN: TE to 0 V				
<b>Connection types</b>	Terminal chamber Plug M 12, 4-pin				
<b>VDE protection class<sup>8)</sup></b>	□				
<b>Circuit protection<sup>9)</sup></b>	A, B, C, D				
<b>Enclosure rating</b>	IP 67				
<b>Ambient temperature <math>T_A</math></b>	Operation -25 °C...+55 °C Storage -40 °C...+70 °C				
<b>Weight</b>	Approx. 120 g				
<b>Material</b>	Housing: ABS; optics: PC				

- 1) Object with 90 % remission (based on standard white DIN 5033)
- 2) Average service life 100,000 h at  $T_A = +25$  °C
- 3) Limit values

- 4) Must be within  $V_s$  tolerances
- 5) Without load
- 6) With resistive load
- 7) With light/dark ratio 1:1
- 8) Reference voltage 50 V DC

- 9) A =  $V_s$  connections reverse-polarity protected
- B = Inputs/outputs reverse-polarity protected
- C = Interference suppression
- D = Outputs overcurrent and short-circuit protected

**Scanning distance**

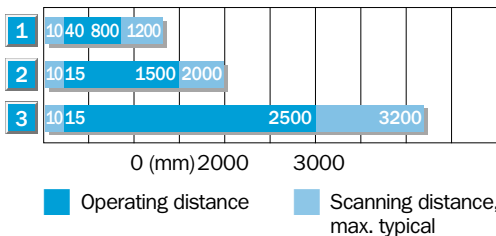

- 1 Scanning range on black, 6 % remission
- 2 Scanning range on grey, 18 % remission
- 3 Scanning range on white, 90 % remission

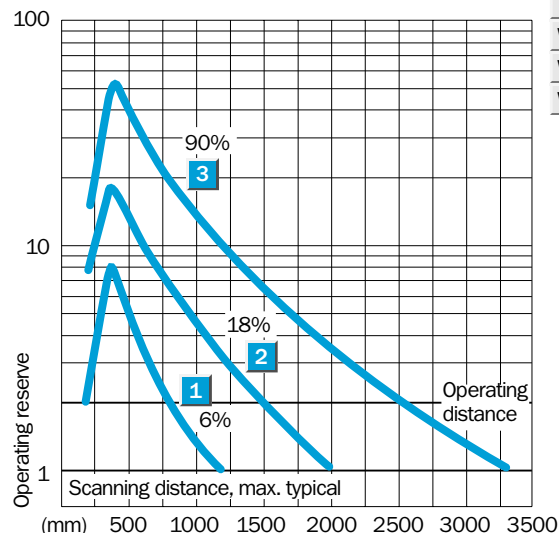

**Order information**

Type	Part no.
WT 260-F 280	6 020 982
WT 260-F 480	6 020 983
WT 260-E 280	6 020 984



**Scanning distance**  
**10...3500 mm**

Photoelectric proximity switches

- Adjustable sensitivity
- Terminal chamber
- Universal current supply, relay output, SPDT, timer optional,  $t_{ON}$  and  $t_{OFF}$  can be connected separately
- Enclosure rating IP 67
- CE noise radiation EN 50081-1 ("Residential standard")

**Dimensional drawing**

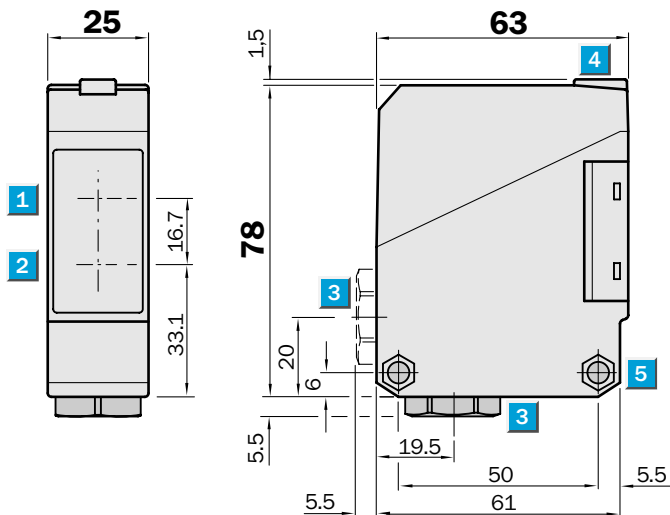

**Adjustments possible**

WT 260-S 280    WT 260-R 280

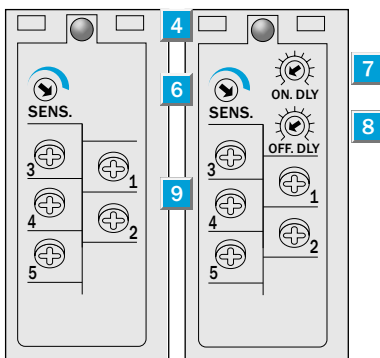

- 1 Centre of optical axis, receiver
- 2 Centre of optical axis, sender
- 3 Cable entry gland 1/2" PF thread for cable diameters from 6 to 10 mm optionally at bottom or rear
- 4 LED signal strength indicator, red
- 5 Through hole  $\varnothing$  5.2 mm on both sides for M 5 hex nut
- 6 Sensitivity adjustment
- 7 Time control ON-delay  $t_{ON}$
- 8 Time control OFF-delay  $t_{OFF}$
- 9 Terminals



**Connection type**

WT 260-S 280  
WT 260-R 280

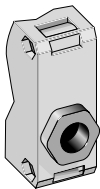

**Terminals**

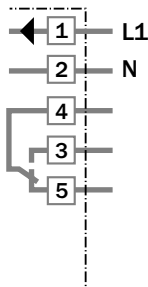

**Time delay**

$t = 0.1 - 10 \text{ s}$

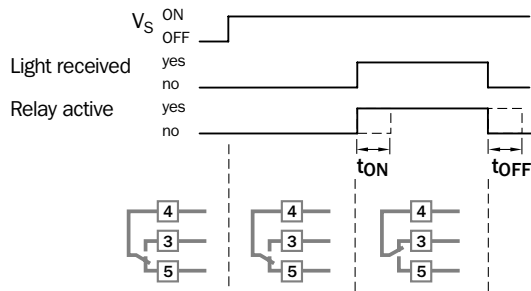

Accessories	page
Mounting brackets*	510

\* included with delivery

Technical data		WT 260-	S 280	R 280								
<b>Scanning distance</b> , max. typical	10...3500 mm, adjustable <sup>1)</sup>											
<b>Operating distance</b>	20...3000 mm, adjustable <sup>1)</sup>											
Sensitivity	Adjustable, potentiometer 270°											
<b>Light source<sup>2)</sup>, light type</b>	LED, infrared light											
Light spot diameter	Approx. 95 mm at 3000 mm											
Angle of dispersion, sender	Approx. 1.7°											
<b>Supply voltage V<sub>S</sub><sup>3)</sup></b>	12...240 V DC											
	24...240 V AC											
Power consumption	≤ 5 VA											
<b>Switching output</b>	Relay, SPDT, electrically isolated											
Switching current I max <sup>4)</sup>	3 A/240 V AC; 3 A/30 V DC											
Light receiver, switching mode	Light-switching											
Response time	≤ 20 ms											
Max. switching frequency <sup>5)</sup>	25/s											
<b>Time delays</b>												
ON delay t <sub>ON</sub>	0.1...10 s, can be connected separately											
OFF delay t <sub>OFF</sub>	0.1...10 s, can be connected separately											
<b>Connection type</b>	Terminal chamber											
<b>CE noise radiation</b>	Level EN 50081-1 ("Residential standard")											
<b>VDE protection class<sup>6)</sup></b>	□											
<b>Circuit protection<sup>7)</sup></b>	A, C											
<b>Enclosure rating</b>	IP 67											
<b>Ambient temperature T<sub>A</sub></b>	Operation - 25 °C...+ 55 °C Storage - 40 °C...+ 70 °C											
<b>Weight</b>	Approx. 120 g											
<b>Material</b>	Housing: ABS; optics: PC											

- 1) Object with 90 % remission (based on standard white DIN 5033)
- 2) Average service life 100,000 h at T<sub>A</sub> = + 25 °C
- 3) ± 10 %
- 4) Provide suitable spark suppression for inductive or capacitive loads
- 5) With light/dark ratio 1:1
- 6) Reference voltage 250 V UC
- 7) A = V<sub>S</sub> connections reverse-polarity protected  
C = Interference suppression

**Scanning distance**

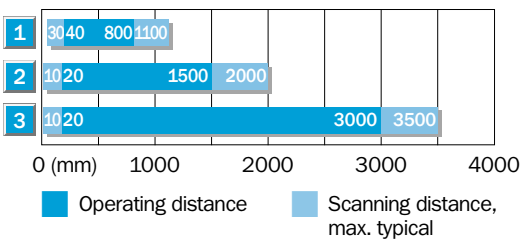

- 1 Scanning range on black, 6 % remission
- 2 Scanning range on grey, 18 % remission
- 3 Scanning range on white, 90 % remission

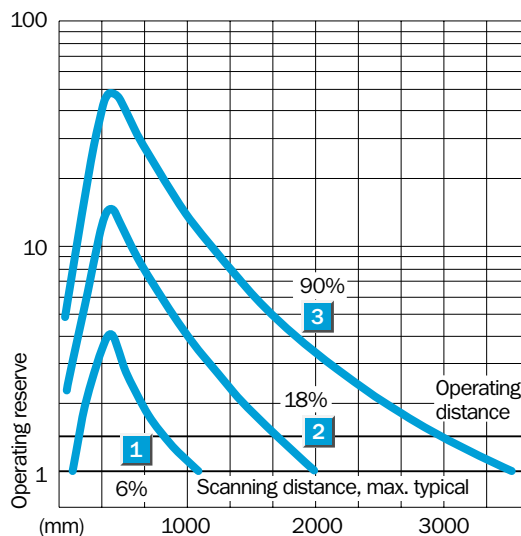

**Order information**

Type	Part no.
WT 260-S 280	6 020 771
WT 260-R 280	6 020 772

**Scanning distance**  
 5...1500 mm  
**Photoelectric proximity switches**

- Adjustable sensitivity
- Terminal chamber or M 12, 4-pin plug
- Test input

**Dimensional drawing**

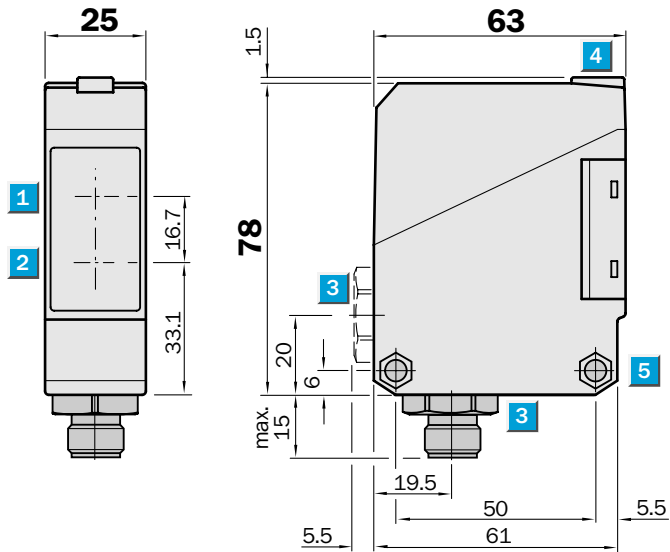

**Adjustments possible**

WT 260-F 270
WT 260-F 470
WT 260-E 270

- 1** Centre of optical axis, receiver
- 2** Centre of optical axis, sender
- 3** Cable entry gland 1/2" PF thread for cable diameters from 6 to 10 mm optionally at bottom or rear; or M 12 equipment plug, bottom
- 4** LED signal strength indicator, yellow, switching output active
- 5** Through hole Ø 5.2 mm on both sides for M 5 hex nut
- 6** Sensitivity adjustment
- 7** Light/dark rotary switch  
L.ON = light-switching, D.ON = dark-switching
- 8** Terminals

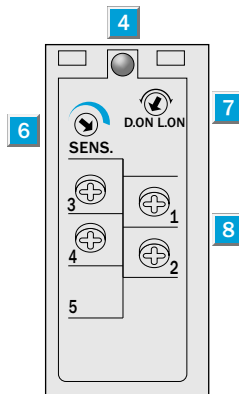

**Connection types**

WT 260-F 270	WT 260-F 470
WT 260-E 270	

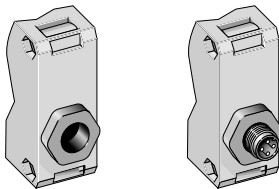

Terminals 4-pin, M 12

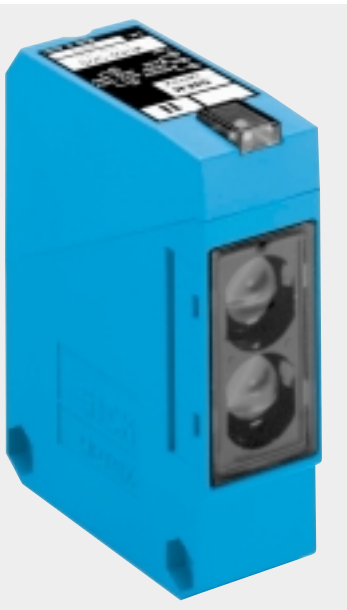
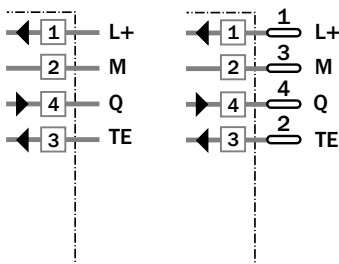

Accessories	page
Cable receptacles	496
Mounting brackets*	510

\* included with delivery

Technical data		WT 260-	F 270	F 470	E 270
<b>Scanning distance</b>	5...1500 mm, adjustable <sup>1)</sup>				
<b>Operating distance</b>	5...1000 mm, adjustable <sup>1)</sup>				
Sensitivity	Adjustable, potentiometer 270°				
<b>Light source<sup>2)</sup>, light type</b>	LED, infrared light				
Light spot diameter	Approx. 45 mm at 1000 mm				
Angle of dispersion, sender	Approx. 2.5°				
<b>Supply voltage <math>V_s</math></b>	10...30 V DC <sup>3)</sup>				
Ripple <sup>4)</sup>	$\leq 5 V_{SS}$				
Current consumption <sup>5)</sup>	$\leq 35$ mA				
<b>Switching outputs</b>	PNP, open collector: Q NPN, open collector: Q				
Output current $I_A$ max.	100 mA				
Light receiver, switching mode	Light-/dark-switching by rotary switch				
Response time <sup>6)</sup>	$\leq 1.5$ ms				
Max. switching frequency <sup>7)</sup>	333/s				
<b>Test input "TE" sender off</b>	PNP: TE to + $V_s$ NPN: TE to 0 V				
<b>Connection types</b>	Terminal chamber Plug M 12, 4-pin				
<b>VDE protection class<sup>8)</sup></b>	<input type="checkbox"/>				
<b>Circuit protection<sup>9)</sup></b>	A, B, C, D				
<b>Enclosure rating</b>	IP 67				
<b>Ambient temperature <math>T_A</math></b>	Operation -25 °C...+55 °C Storage -40 °C...+70 °C				
<b>Weight</b>	Approx. 120 g				
<b>Material</b>	Housing: ABS; optics: PC				

- |  |                                    |  |   |
|--|------------------------------------|--|---|
| 1) Object with 90 % remission (based on standard white DIN 5033) | 4) Must be within $V_s$ tolerances | 9) A = $V_s$ connections reverse-polarity protected<br>B = Inputs/outputs reverse-polarity protected | C = Interference suppression<br>D = Outputs overcurrent and short-circuit protected |
| 2) Average service life 100,000 h at $T_A = +25$ °C              | 5) Without load                    |  |   |
| 3) Limit values  | 6) With resistive load             |  |   |
|  | 7) With light/dark ratio 1:1       |  |   |
|  | 8) Reference voltage 50 V DC       |  |   |

**Scanning distance**

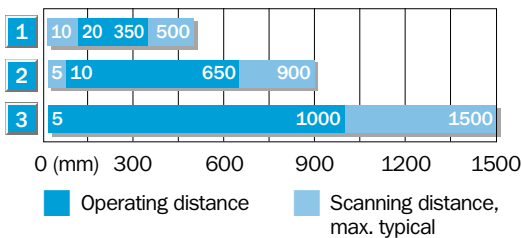

- |   |   |
|---|---|
| 1 | Scanning range on black, 6 % remission  |
| 2 | Scanning range on grey, 18 % remission  |
| 3 | Scanning range on white, 90 % remission |

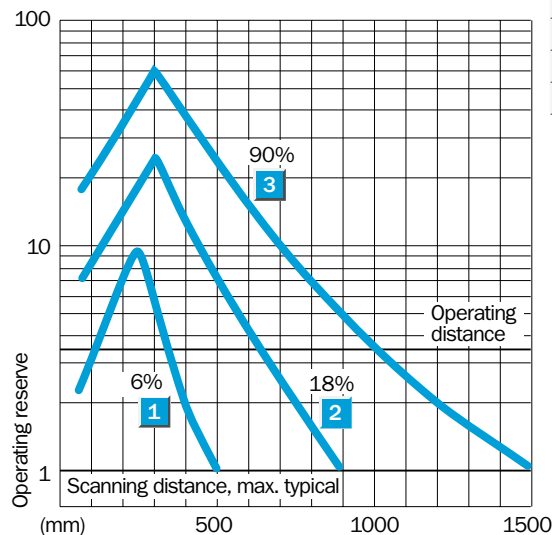

**Order information**

Type	Part no.
WT 260-F 270	6 020 979
WT 260-F 470	6 020 980
WT 260-E 270	6 020 981

**Scanning distance**  
**5...1700 mm**  
 Photoelectric proximity switches

- Adjustable sensitivity
- Terminal chamber
- Universal current supply, Relay output, SPDT, timer optional,  $t_{ON}$  and  $t_{OFF}$  can be connected separately
- Enclosure rating IP 67
- CE noise radiation EN 50081-1 ("Residential standard")

**Dimensional drawing**

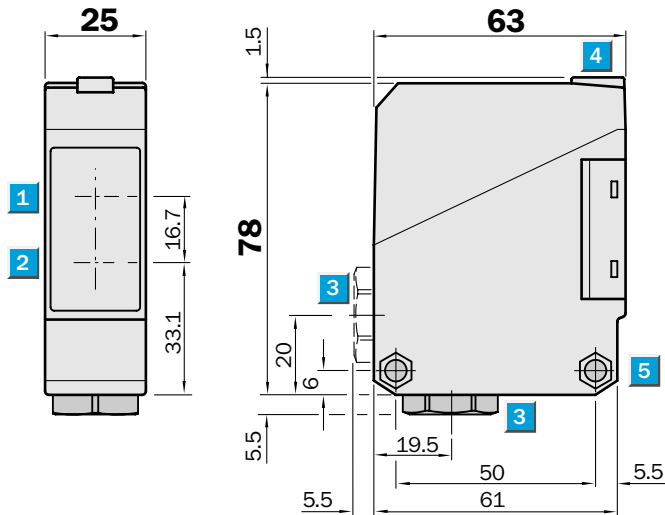

**Adjustments possible**

WT 260-S 270    WT 260-R 270

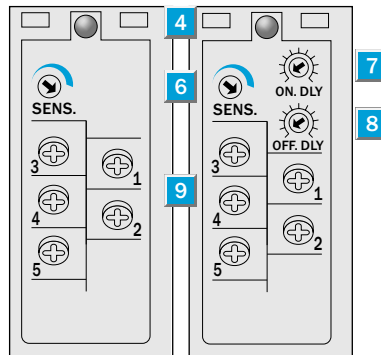

- 1 Centre of optical axis, receiver
- 2 Centre of optical axis, sender
- 3 Cable entry gland 1/2" PF thread for cable diameters from 6 to 10 mm optionally at bottom or rear
- 4 LED signal strength indicator, red
- 5 Through hole  $\varnothing$  5.2 mm on both sides for M 5 hex nut
- 6 Sensitivity adjustment
- 7 Time control ON-delay  $t_{ON}$
- 8 Time control OFF-delay  $t_{OFF}$
- 9 Terminals



**Connection type**

WT 260-S 270  
WT 260-R 270

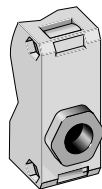

**Terminals**

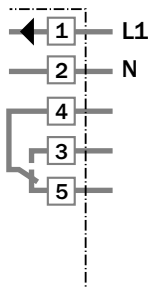

**Time delay**

$t = 0.1 - 10 \text{ s}$

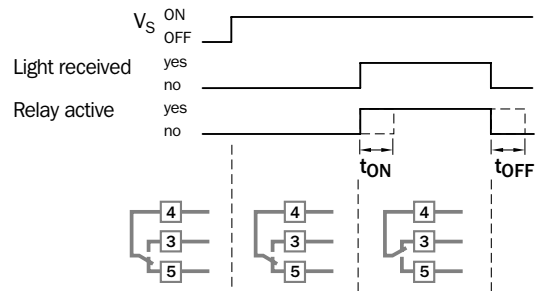

Accessories	page
Mounting brackets*	510

\* included with delivery

Technical data		WT 260-	S 270	R 270								
<b>Scanning distance</b> , max. typical	5...1700 mm, adjustable <sup>1)</sup>											
<b>Operating distance</b>	5...1300 mm, adjustable <sup>1)</sup>											
Sensitivity	Adjustable, potentiometer 270°											
<b>Light source<sup>2)</sup>, light type</b>	LED, infrared light											
Light spot diameter	Approx. 60 mm at 1300 mm											
Angle of dispersion, sender	Approx. 1.8°											
<b>Supply voltage <math>V_s</math><sup>3)</sup></b>	12...240 V DC											
	24...240 V AC											
Power consumption	≤ 5 VA											
<b>Switching output</b>	Relay, SPDT, electrically isolated											
Switching current $I_{max}$ <sup>4)</sup>	3 A/240 V AC; 3 A/30 V DC											
Light receiver, switching mode	Light-switching											
Response time	≤ 20 ms											
Max. switching frequency <sup>5)</sup>	25/s											
<b>Time delays</b>												
ON-delay $t_{ON}$	0.1...10 s, can be connected separately											
OFF-delay $t_{OFF}$	0.1...10 s, can be connected separately											
<b>Connection type</b>	Terminal chamber											
<b>CE noise radiation</b>	Level EN 50081-1 ("Residential standard")											
<b>VDE protection class<sup>6)</sup></b>	□											
<b>Circuit protection<sup>7)</sup></b>	A, C											
<b>Enclosure rating</b>	IP 67											
<b>Ambient temperature <math>T_A</math></b>	Operation -25 °C...+55 °C Storage -40 °C...+70 °C											
<b>Weight</b>	Approx. 120 g											
<b>Material</b>	Housing: ABS; optics: PC											

- 1) Object with 90 % remission (based on standard white DIN 5033)
- 2) Average service life 100,000 h at  $T_A = +25 °C$
- 3) ± 10 %
- 4) Provide suitable spark suppression for inductive or capacitive loads
- 5) With light/dark ratio 1:1
- 6) Reference voltage 250 V UC
- 7) A =  $V_s$  connections reverse-polarity protected  
C = Interference suppression

**Scanning distance**

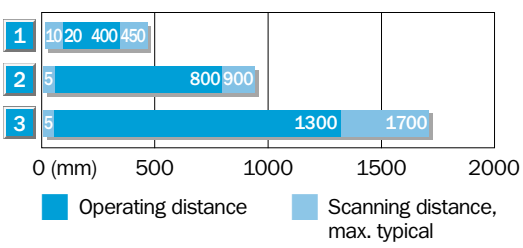

- 1 Scanning range on black, 6 % remission
- 2 Scanning range on grey, 18 % remission
- 3 Scanning range on white, 90 % remission

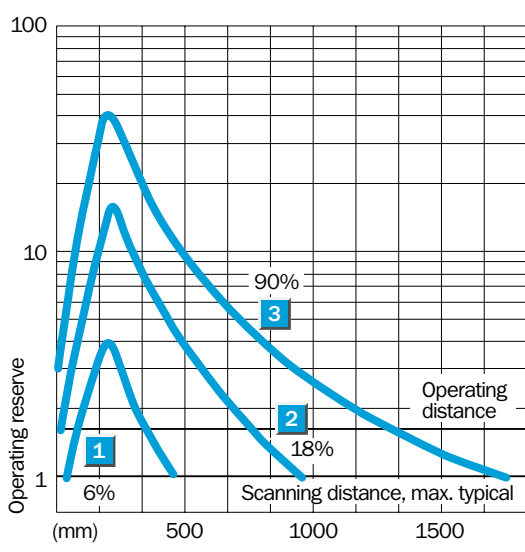

Order information	
Type	Part no.
WT 260-S 270	6 020 769
WT 260-R 270	6 020 770

**Scanning range**  
 0.01...14 m

Photoelectric reflex switches

- Polarising filter providing reliable detection even of objects with reflective surfaces
- Adjustable sensitivity
- Terminal chamber or M 12, 4-pin plug
- Test input

Dimensional drawing

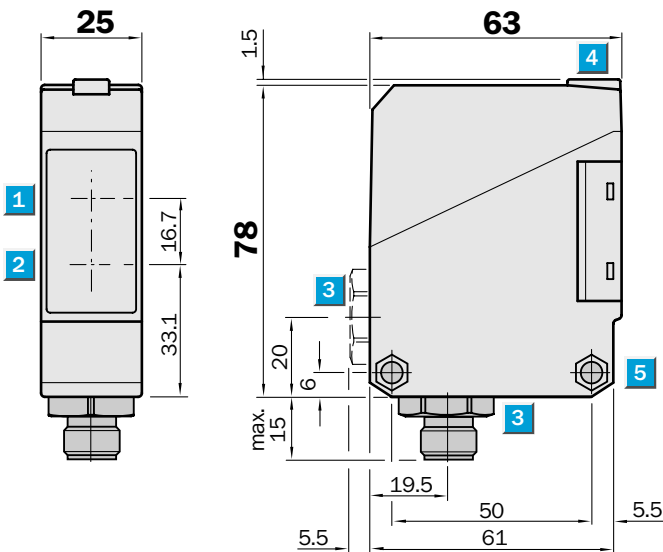

Adjustments possible

WL 260-F 270
WL 260-F 470
WL 260-E 270

- 1 Centre of optical axis, receiver
- 2 Centre of optical axis, sender
- 3 Cable entry gland 1/2" PF thread for cable diameters from 6 to 10 mm optionally at bottom or rear; or M 12 equipment plug, bottom
- 4 LED signal strength indicator, yellow, switching output active
- 5 Through hole Ø 5.2 mm on both sides for M 5 hex nut
- 6 Sensitivity adjustment
- 7 Light/dark rotary switch  
L.ON = light-switching, D.ON = dark-switching
- 8 Terminals

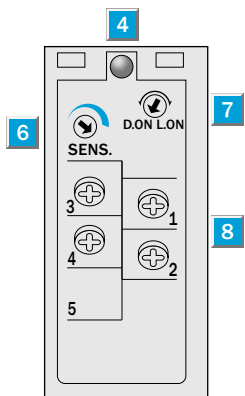

Connection types

WL 260-F 270	WL 260-F 470
WL 260-E 270	

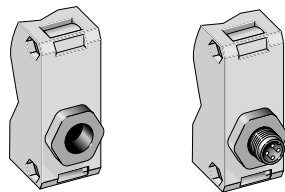

Terminals 4-pin, M 12

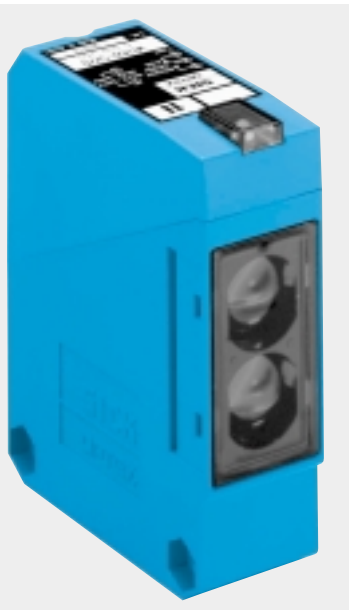
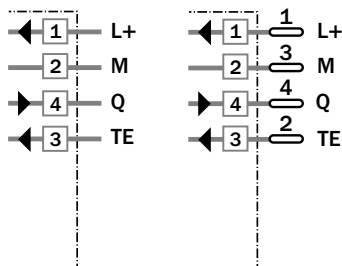

Accessories	page
Cable receptacles	496
Mounting brackets*	510
Reflector P 250*	520

\* included with delivery

Technical data		WL 260-	F 270	F 470	E 270
<b>Scanning range</b> , max. typical/on refl.	0.01...14 m/PL 80 A				
	max. typical/on refl. 0.01...9.5 m/P 250 (included)				
<b>Operating range</b>	0.01...8 m/P 250				
Sensitivity	Adjustable, potentiometer 270°				
<b>Light source<sup>1)</sup>, light type</b>	LED, visible red light with polarising filter				
Light spot diameter	Approx. 240 mm at 8 m				
Angle of dispersion, sender	Approx. 1.7°				
<b>Supply voltage V<sub>s</sub></b>	10...30 V DC <sup>2)</sup>				
Ripple <sup>3)</sup>	≤ 5 V <sub>SS</sub>				
Current consumption <sup>4)</sup>	≤ 35 mA				
<b>Switching outputs</b>	PNP, open collector: Q NPN, open collector: Q				
Output current I <sub>A</sub> max.	100 mA				
Light receiver, switching mode	Light /dark-switching by rotary switch				
Response time <sup>5)</sup>	≤ 1.5 ms				
Max. switching frequency <sup>6)</sup>	333/s				
<b>Test input "TE" sender off</b>	PNP: TE to + V <sub>s</sub> NPN: TE to 0 V				
<b>Connection types</b>	Terminal chamber M 12 plug, 4-pin				
<b>VDE protection class<sup>7)</sup></b>	□				
<b>Circuit protection<sup>8)</sup></b>	A, B, C, D				
<b>Enclosure rating</b>	IP 67				
<b>Ambient temperature T<sub>A</sub></b>	Operation - 25 °C...+ 55 °C Storage - 40 °C...+ 70 °C				
<b>Weight</b>	Approx. 120 g				
<b>Material</b>	Housing: ABS; optics: PMMA				

- 1) Average service life 100,000 h at T<sub>A</sub> = +25 °C
- 2) Limit values
- 3) Must be within V<sub>s</sub> tolerances
- 4) Without load
- 5) With resistive load
- 6) With light/dark ratio 1:1
- 7) Reference voltage 50 V DC
- 8) A = V<sub>s</sub> connections reverse-polarity protected  
B = Inputs/outputs reverse-polarity protected  
C = Interference suppression  
D = Outputs overcurrent and short-circuit protected

**Scanning range and operating reserve**

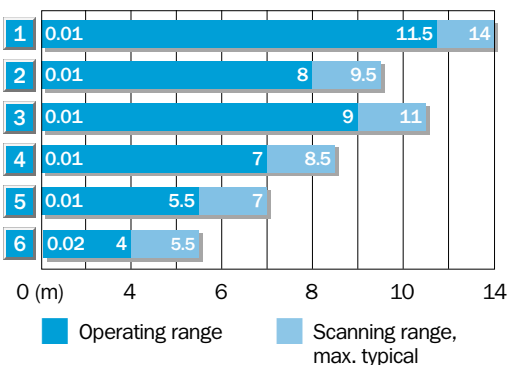

Reflector type	Operating range
1 PL 80 A	0.01...11.5 m
2 P 250	0.01...8.0 m
3 PL 50 A or PL 40 A	0.01...9.0 m
4 PL 30 A or PL 31 A	0.01...7.0 m
5 PL 20 A	0.01...5.5 m
6 Reflective tape «Diamond Grade»	0.02...4.0 m

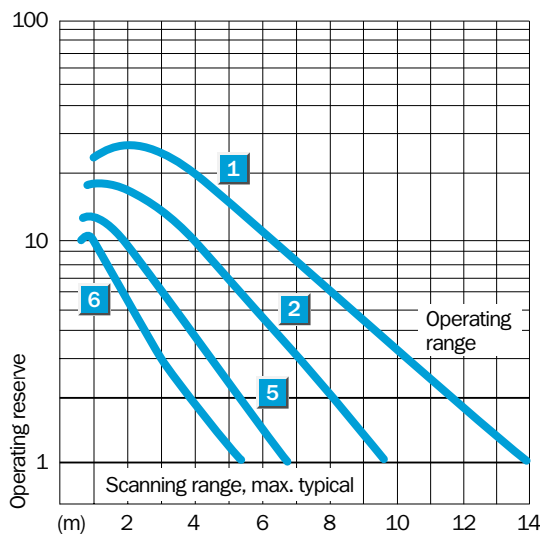

**Order information**

Type	Part no.
WL 260-F 270	6 020 976
WL 260-F 470	6 020 977
WL 260-E 270	6 020 978



**Scanning range**  
 0.01...15 m

Photoelectric reflex switches

- Polarising filter providing reliable detection even of objects with reflective surfaces
- Terminal chamber
- Universal current supply, relay output, SPDT, timer optional,  $t_{ON}$  and  $t_{OFF}$  can be connected separately
- Enclosure rating IP 67
- CE noise radiation EN 50081-1 ("Residential standard")

Dimensional drawing

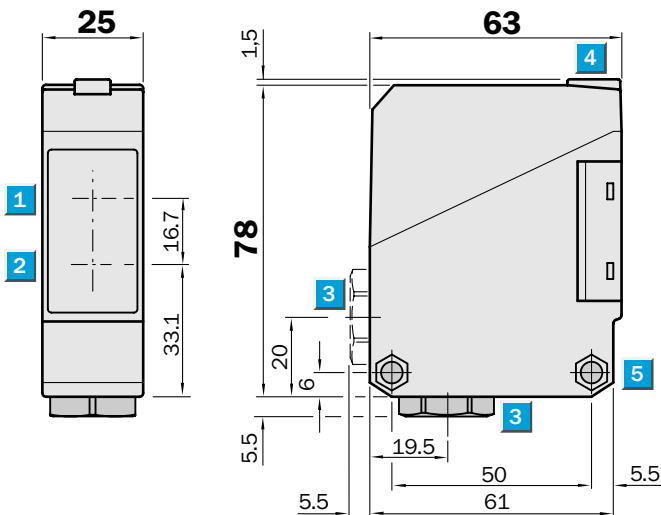

Adjustments possible

WL 260-S 270    WL 260-R 270

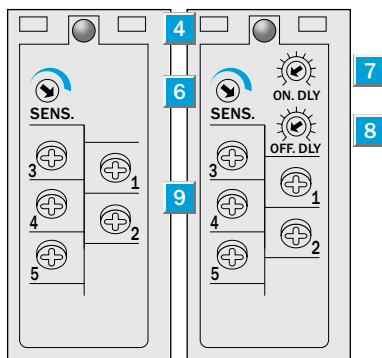

- 1 Centre of optical axis, receiver
- 2 Centre of optical axis, sender
- 3 Cable entry gland 1/2" PF thread for cable diameters from 6 to 10 mm optionally at bottom or rear
- 4 LED signal strength indicator, red
- 5 Through hole  $\varnothing$  5.2 mm on both sides for M 5 hex nut
- 6 Sensitivity adjustment
- 7 Time control ON-delay  $t_{ON}$
- 8 Time control OFF-delay  $t_{OFF}$
- 9 Terminals

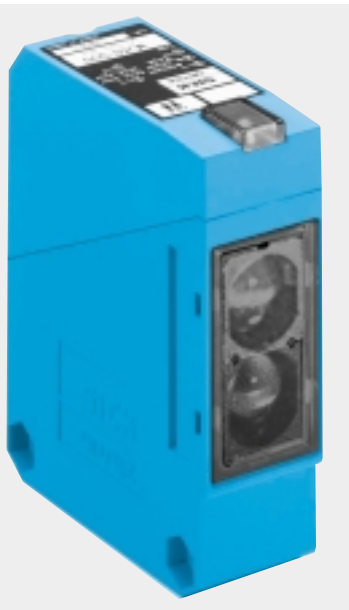

Connection type

WL 260-S 270  
WL 260-R 270

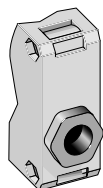

Terminals

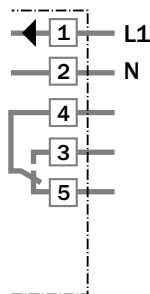

Time delay

$t = 0.1 - 10 \text{ s}$

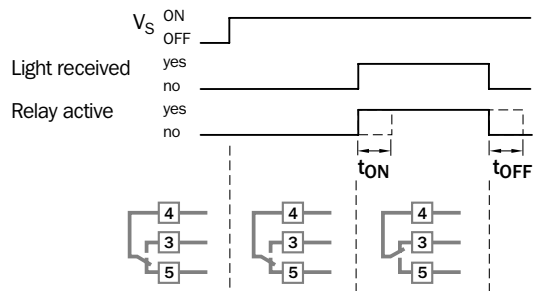

Accessories	page
Mounting brackets*	510
Reflector P 250*	520

\* included with delivery

Technical data		WL 260-	S 270	R 270										
<b>Scanning range</b> , max. typical/on refl.	0.01...15 m/ PL 80 A													
	max. typical/on refl. 0.01...11 m/P 250 (included)													
<b>Operating range</b>	0.01...10 m/P 250													
Sensitivity	Adjustable, potentiometer 270°													
<b>Light source<sup>1)</sup>, light type</b>	LED, visible red light													
	with polarising filter													
Light spot diameter	Approx. 300 mm at 10 m													
Angle of dispersion, sender	Approx. 1.7°													
<b>Supply voltage <math>V_s</math><sup>2)</sup></b>	12...240 V DC													
	24...240 V AC													
Power consumption	≤ 5 VA													
<b>Switching output</b>	Relay, SPDT, electrically isolated													
Switching current $I_A$ max. <sup>3)</sup>	3 A/240 V AC; 3 A/30 V DC													
Light receiver, switching mode	Light-switching													
Response time	≤ 20 ms													
Max. switching frequency <sup>4)</sup>	25/s													
<b>Time delays</b>														
ON delay $t_{ON}$	0.1...10 s, can be connected separately													
OFF delay $t_{OFF}$	0.1...10 s, can be connected separately													
<b>Connection type</b>	Terminal chamber													
<b>CE noise radiation</b>	Level EN 50081-1													
	("Residential standard")													
<b>VDE protection class<sup>5)</sup></b>	□													
<b>Circuit protection<sup>6)</sup></b>	A, C													
<b>Enclosure rating</b>	IP 67													
<b>Ambient temperature <math>T_A</math></b>	Operation - 25 °C...+ 55 °C													
	Storage - 40 °C...+ 70 °C													
<b>Weight</b>	Approx. 120 g													
<b>Material</b>	Housing: ABS; optics: PMMA													

1) Average service life 100,000 h at  $T_A = + 25 °C$   
 2) ± 10 %

3) Provide suitable spark suppression for inductive or capacitive loads  
 4) With light/dark ratio 1:1

5) Reference voltage 250 V UC  
 6) A =  $V_s$  connections reverse-polarity protected  
 C = Interference suppression

**Scanning range and operating reserve**

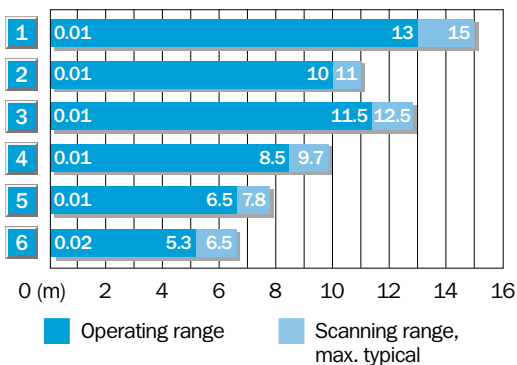

Reflector type	Operating range
1 PL 80 A	0.01...13.0 m
2 P 250	0.01...10.0 m
3 PL 50 A or PL 40 A	0.01...11.5 m
4 PL 30 A or PL 31 A	0.01...8.5 m
5 PL 20 A	0.01...6.5 m
6 Reflective tape «Diamond Grade»	0.01...5.3 m

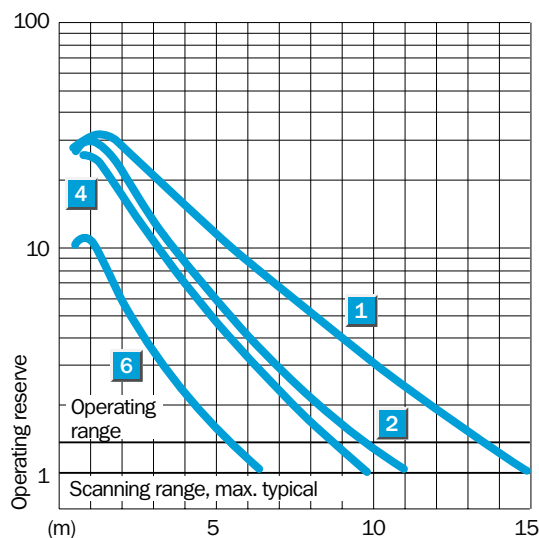

**Order information**

Type	Part no.
WL 260-S 270	6 020 767
WL 260-R 270	6 020 768

**Scanning range**  
30 m

Through-beam photoelectric switches

- Adjustable sensitivity
- Terminal chamber or M 12, 4-pin plug
- Test input



**Dimensional drawing**

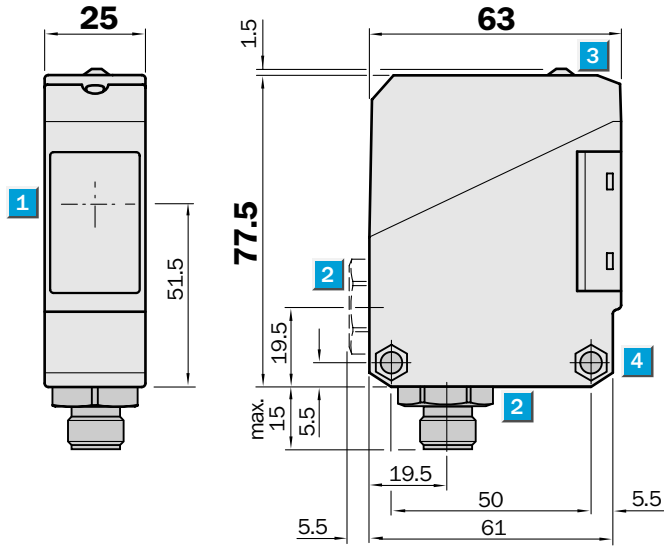

**Adjustments possible**

- WS/WE 260-F 230
- WS/WE 260-F 430
- WS/WE 260-E 230

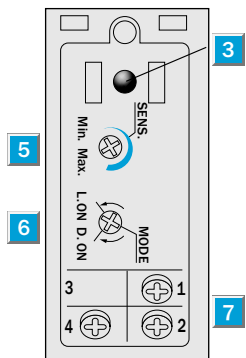

- 1 Centre of optical axis, sender/receiver
- 2 Cable entry gland 1/2" PF thread for cable diameters from 6 to 10 mm optionally at bottom or rear; or M 12 equipment plug, bottom
- 3 LED signal strength indicator, red
- 4 Through hole  $\varnothing$  5.2 mm on both sides for M 5 hex nut
- 5 Sensitivity adjustment
- 6 Light/dark rotary switch  
L.ON = light-switching, D.ON = dark-switching
- 7 Terminals

**Connection types**

- WS/WE 260-F 230
- WS/WE 260-F 430
- WS/WE 260-E 230

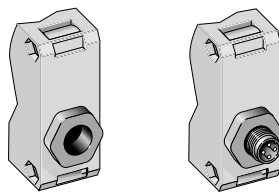

Terminals	4-pin, M 12
WS 260-G 230	WS 260-G 430

**Sender**



**Receiver**

WE 260-E 230	WE 260-F 430
WE 260-F 230	

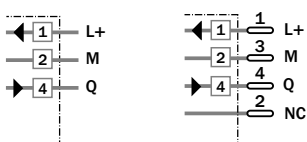

Accessories	page
Cable receptacles M 12	496
Mounting brackets*	510
Slotted masks	556

\* included with delivery



Technical data		WS/WE 260-	F 230	F 430	E 230
Scanning range, max. typical	30 m				
Operating range	20 m				
Sensitivity	Adjustable, potentiometer 270°				
<b>Light source<sup>1)</sup>, light type</b>	LED, infrared light				
Light spot diameter	Approx. 350 mm at 20 m				
Angle of dispersion, sender	Approx. 1°				
Angle of dispersion, receiver	Approx. 20°				
<b>Supply voltage V<sub>S</sub></b>	10...30 V DC <sup>2)</sup>				
Ripple <sup>3)</sup>	≤ 5 V <sub>SS</sub>				
Current consumption <sup>4)</sup>					
sender	≤ 20 mA				
receiver	≤ 35 mA				
<b>Switching outputs</b>	PNP, open collector: Q NPN, open collector: Q				
Output current I <sub>A</sub> max.	100 mA				
Light receiver, switching mode	Light-/dark-switching by rotary switch				
Response time <sup>5)</sup>	≤ 1 ms				
Max. switching frequency <sup>6)</sup>	500/s				
<b>Test input "TE" sender off</b>	PNP, NPN: TE to 0 V				
<b>Connection types</b>	Terminal chamber M 12 plug, 4 pin				
<b>VDE protection class<sup>7)</sup></b>	□				
<b>Circuit protection<sup>8)</sup></b>					
sender	A, B				
receiver	A, B, C, D				
<b>Enclosure rating</b>	IP 66				
<b>Ambient temperature T<sub>A</sub></b>	Operation - 25 °C...+ 55 °C Storage - 40 °C...+ 70 °C				
<b>Weight</b>	Approx. 120 g				
<b>Material</b>	Housing: ABS; optics: PC				

- 1) Average service life 100000 h at T<sub>A</sub> = + 25 °C
- 2) Limit values
- 3) Must be within V<sub>S</sub> tolerances
- 4) Without load
- 5) With resistive load
- 6) With light/dark ratio 1:1
- 7) Reference voltage 50 V DC
- 8) A = V<sub>S</sub> connections reverse-polarity protected  
B = Inputs/outputs reverse-polarity protected
- C = Interference suppression  
D = Outputs overcurrent and short-circuit protected

**Scanning range and operating reserve**

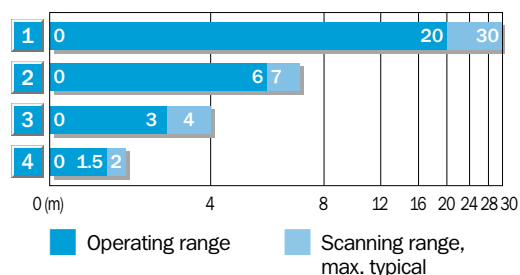

**Scanning range reduction when using slotted masks**

1	Without slotted mask
2	Slot width 5 mm
3	Slot width 2 mm
4	Slot width 1 mm

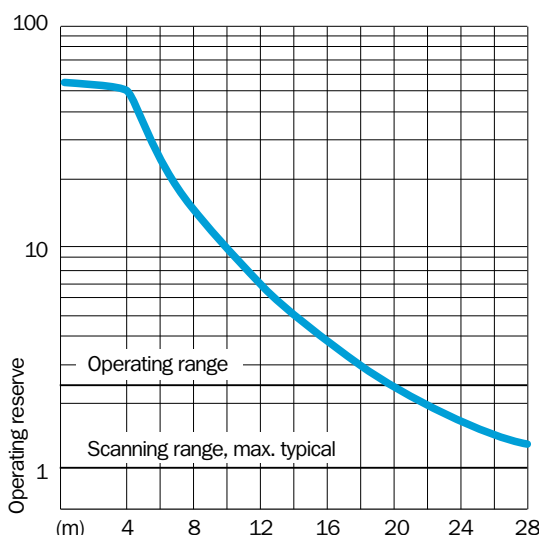

**Order information**

Type	Part no.
WS/WE 260-F 230	6 020 052
WS/WE 260-E 230	6 020 051
WS/WE 260-F 430	6 020 053

**Scanning range**  
45 m

Through-beam photoelectric switches

- Adjustable sensitivity
- Terminal chamber
- Universal current supply, relay output, SPDT, timer optional,  $t_{ON}$  and  $t_{OFF}$  can be connected separately
- Enclosure rating IP 67
- CE noise radiation EN 50081-1 ("Residential standard")

**Dimensional drawing**

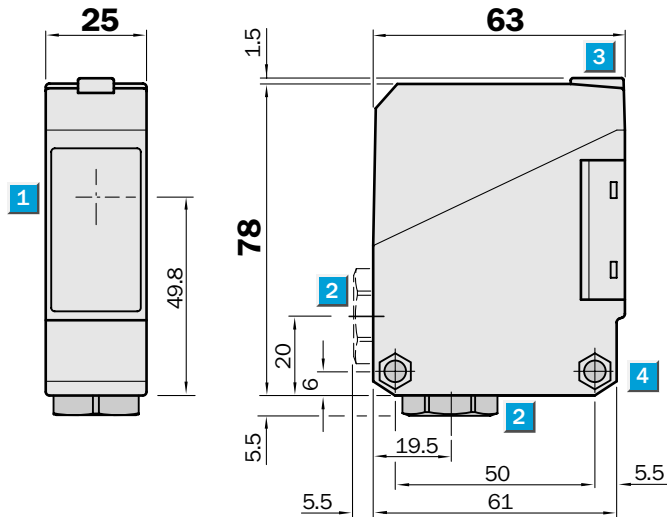

**Adjustments possible**

WS/WE 260-S 270    WS/WE 260-R 270

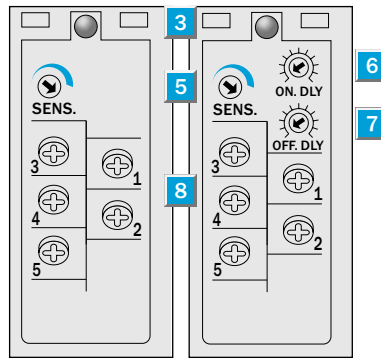

- 1 Centre of optical axis, sender and receiver
- 2 Cable entry gland 1/2" PF thread for cable diameters from 6 to 10 mm optionally at bottom or rear
- 3 LED signal strength indicator, red
- 4 Through hole  $\varnothing$  5.2 mm on both sides for M 5 hex nut
- 5 Sensitivity adjustment
- 6 Time control ON-delay  $t_{ON}$
- 7 Time control OFF-delay  $t_{OFF}$
- 8 Terminals



**Connection type**

WS/WE 260-S 270  
WS/WE 260-R 270

**Time delay**

$t = 0.1 - 10 \text{ s}$

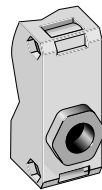
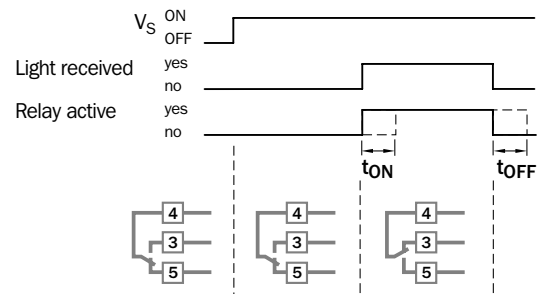

**Terminals**

WS 260-S 270

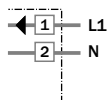

Receiver WE 260-S 270

WE 260-R 270

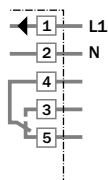

Accessories	page
Mounting brackets*	510

\* included with delivery

Technical data		WS/WE 260-	S 270	R 270								
<b>Scanning range</b> , max. typical	45 m											
<b>Operating range</b>	40 m											
Sensitivity	Adjustable, potentiometer 270°											
<b>Light source<sup>1)</sup>, light type</b>	LED, visible red light											
Light spot diameter	Approx. 700 mm at 40 m											
Angle of dispersion, sender	Approx. 1°											
Angle of dispersion, receiver	Approx. 20°											
<b>Supply voltage V<sub>S</sub><sup>2)</sup></b>	12...240 V DC											
	24...240 V AC											
Power consumption												
Sender	≤ 4 VA											
Receiver	≤ 5 VA											
<b>Switching output</b>	Relay, SPDT, electrically isolated											
Switching current I <sub>A</sub> max. <sup>3)</sup>	3 A/240 V AC; 3 A/30 V DC											
Light receiver, switching mode	Light-switching											
Response time	≤ 20 ms											
Max. switching frequency <sup>4)</sup>	25/s											
<b>Time delays</b>												
ON-delay t <sub>ON</sub>	0.1...10 s, can be connected separately											
OFF-delay t <sub>OFF</sub>	0.1...10 s, can be connected separately											
<b>Connection type</b>	Terminal chamber											
<b>CE noise radiation</b>	Level EN 50081-1 ("Residential standard")											
<b>VDE protection class<sup>5)</sup></b>	□											
<b>Circuit protection<sup>6)</sup></b>	A, C											
<b>Enclosure rating</b>	IP 67											
<b>Ambient temperature T<sub>A</sub></b>	Operation - 25 °C...+ 55 °C Storage - 40 °C...+ 70 °C											
<b>Weight</b>	Approx. 120 g											
<b>Material</b>	Housing: ABS; optics: PC											

1) Average service life 100,000 h at T<sub>A</sub> = + 25 °C  
2) ± 10 %

3) Provide suitable spark suppression for inductive or capacitive loads  
4) With light/dark ratio 1:1

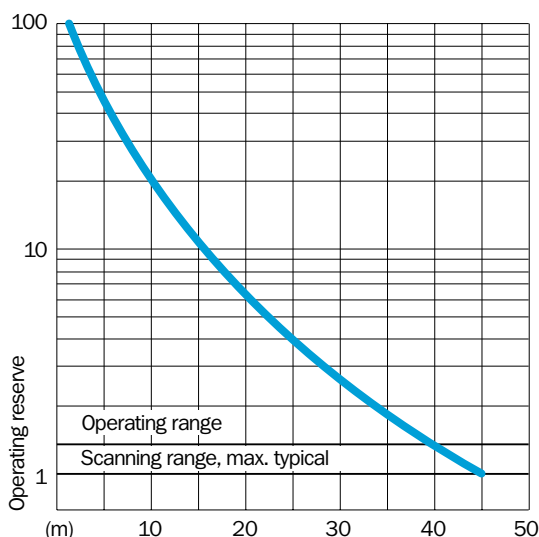
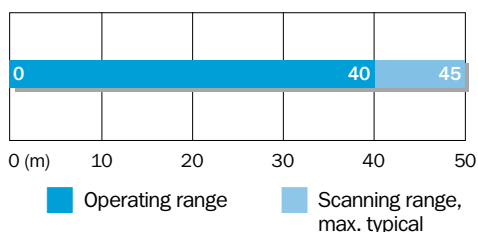

5) Reference voltage 250 V UC  
6) A = V<sub>S</sub> connections reverse-polarity protected  
C = Interference suppression

**Scanning range and operating reserve**



**Order information**

Type	Part no.
WS/WE 260-S 270	6 020 773
WS/WE 260-R 270	6 020 774

	<b>Scanning range</b> max. 800 mm
<b>Through-beam systems</b>	
	<b>Scanning distance</b> max. 65 (110) mm
<b>Proximity systems</b>	

- Wide range of fibre-optic cables for through-beam and proximity applications
- Easy adaption of fibre-optic cable using cap nut
- Adjustable sensitivity
- Terminal chamber, at bottom or rear or M 12 plug, 4-pin
- Test input

**Dimensional drawing**

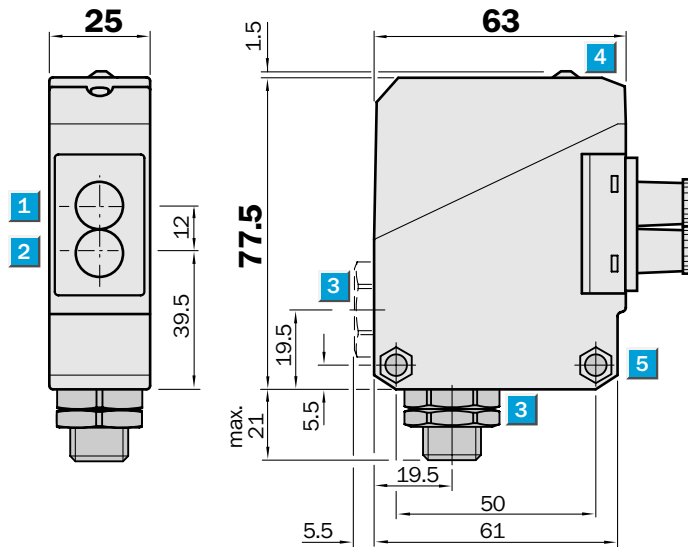

**Adjustments possible**

WLL 260-F 240
WLL 260-F 440
WLL 260-E 240

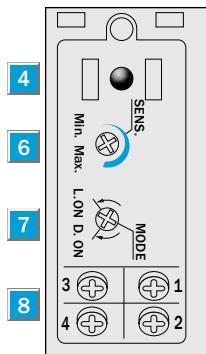

- 1** Centre of optical axis, receiver
- 2** Centre of optical axis, sender
- 3** Cable entry gland 1/2" PF thread for cable diameters from 6 to 10 mm optionally at bottom or rear; or M 12 equipment plug, bottom
- 4** LED signal strength indicator, red
- 5** Through hole  $\varnothing$  5.2 mm on both sides for M 5 hex nut
- 6** Sensitivity adjustment
- 7** Light/dark rotary switch  
L.ON = light-switching, D.ON = dark-switching
- 8** Terminals

**Connection types**

WLL 260-E 240	WLL 260-F 440
WLL 260-F 240	

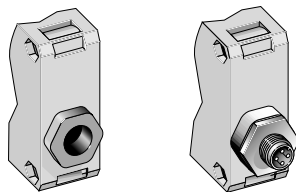

Terminals 4-pin, M 12

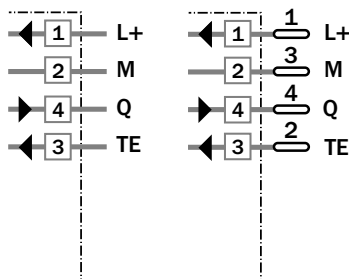

Accessories	page
Cable receptacles	496
Mounting brackets*	510
Fibre-optic cable	528

\* included with delivery

Technical data		WLL 260-	F 240	F 440	E 240						
<b>Suitable fibre-optic cables</b>	Fibre-optic cable series LIS/LBS see page 552										
<b>Scanning distance/ranges</b>	Depends on the fibre-optic cable used										
<b>Through-beam system</b>											
Scanning distance, max. typical <sup>1)</sup>	0...65 mm										
	0...110 mm w. special fibre-optic cable										
Scanning range <sup>1)</sup>	0...50 mm										
	0...90 mm w. special fibre-optic cable										
<b>Proximity system</b>											
Scanning range, max. typical	0...800 mm										
Operating range	0...700 mm										
Sensitivity	Adjustable, potentiometer 270°										
<b>Light source<sup>2)</sup>, light type</b>											
Light source <sup>2)</sup> , light type	LED, visible red light										
Light spot diameter	Depends on scanning range										
Aperture fibre-optic cable	Approx. 65°										
<b>Supply voltage V<sub>S</sub></b>											
Supply voltage V <sub>S</sub>	10...30 V DC <sup>3)</sup>										
Ripple <sup>4)</sup>	≤ 5 V <sub>SS</sub>										
Current consumption <sup>5)</sup>	≤ 35 mA										
<b>Switching outputs</b>											
Switching outputs	PNP, open collector: Q NPN, open collector: Q										
Output current I <sub>A</sub> max.	100 mA										
Light receiver, switching mode	Light-/dark-switching by rotary switch										
Response time <sup>6)</sup>	≤ 0.7 ms										
Max. switching frequency <sup>7)</sup>	700/s										
<b>Test input "TE" sender off</b>											
Test input "TE" sender off	PNP: TE to + V <sub>S</sub> NPN: TE to 0 V										
<b>Connection types</b>											
Connection types	Terminal chamber Plug M 12, 4-pin										
<b>VDE protection class<sup>8)</sup></b>	□										
<b>Circuit protection<sup>9)</sup></b>	A, B, C, D										
<b>Enclosure rating</b>	IP 66										
<b>Ambient temperature T<sub>A</sub></b>											
Ambient temperature T <sub>A</sub>	Operation -25 °C...+55 °C Storage -40 °C...+70 °C										
<b>Weight</b>	Approx. 120 g										
<b>Material</b>	Housing: ABS										

1) Object with 90 % remission (based on standard white DIN 5033)  
 2) Average service life 100,000 h at T<sub>A</sub> = +25 °C  
 3) Limit values  
 4) Must be within V<sub>S</sub> tolerances

5) Without load  
 6) With resistive load  
 7) With light/dark ratio 1:1  
 8) Reference voltage 50 V DC

9) A = V<sub>S</sub> connections reverse-polarity protected  
 B = Inputs/outputs reverse-polarity protected  
 C = Interference suppression  
 D = Outputs overcurrent and short-circuit protected

Order information	
Type	Part no.
WLL 260-F 240	6 020 064
WLL 260-F 440	6 020 065
WLL 260-E 240	6 020 063



	<b>Scanning range</b> max. 800 mm
<b>Through-beam systems</b>	
	<b>Scanning distance</b> max. 65 (110) mm
<b>Proximity systems</b>	

- Wide range of fibre-optic cables for through-beam and proximity applications
- Easy adaption of fibre-optic cable using cap nut
- Adjustable sensitivity
- Terminal chamber, at bottom or rear
- Universal current supply, relay output, SPST, timer optional

**Dimensional drawing**

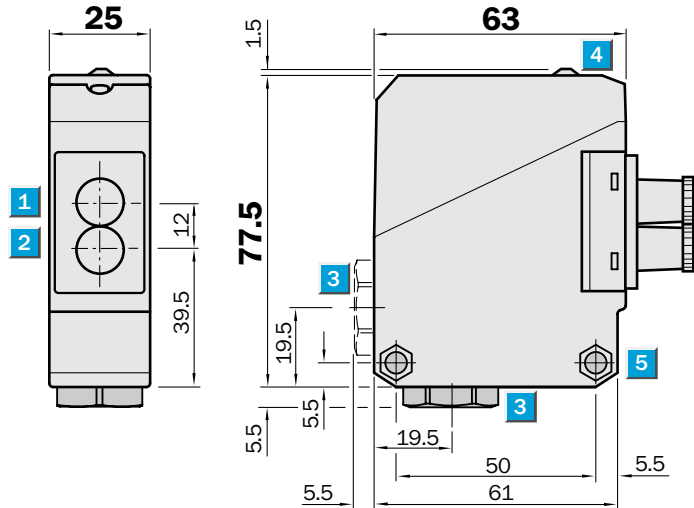

**Adjustments possible**

WLL 260-S 240	WLL 260-R 240
---------------	---------------

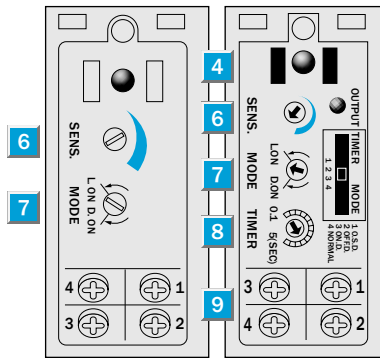

- 1 Centre of optical axis, receiver
- 2 Centre of optical axis, sender
- 3 Cable entry gland 1/2" PF thread for cable diameters from 6 to 10 mm optionally at bottom or rear
- 4 LED signal strength indicator, red
- 5 Through hole  $\varnothing$  5.2 mm on both sides for M 5 hex nut
- 6 Sensitivity adjustment
- 7 Light/dark rotary switch  
L.ON = light-switching,  
D.ON = dark-switching
- 8 Time range control
- 9 Terminals
- 1 0 Red LED status indicator, switching output active
- 1 1 Time delay selector switch  
O.S.D. = One Shot  
OFF.D. = OFF delay  
ON.D. = ON delay  
Normal = No delay



**Connection type**

WLL 260-S 240
WLL 260-R 240

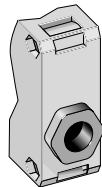

**Terminals**

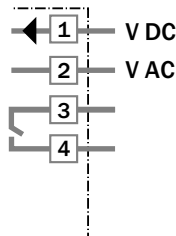

<b>Accessories</b>	page
Mounting brackets*	510
Fibre-optic cable	528

\* included with delivery

**Time delay**

t = 0.1 - 5 s

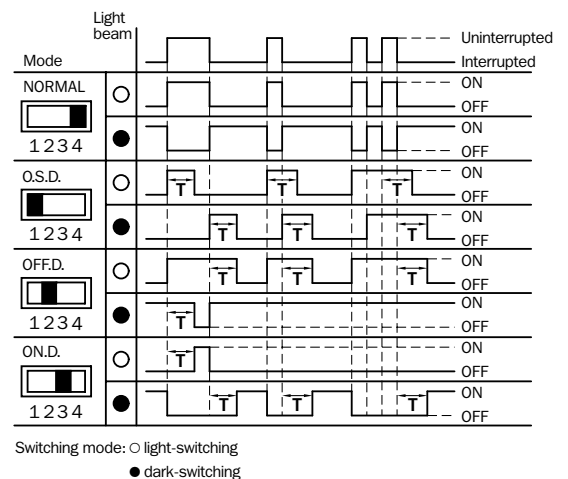

Technical data		WLL 260-	S 240	R 440								
<b>Suitable fibre-optic cable</b>	Fibre-optic cable series LIS/LBS see page 552											
<b>Scanning distance/ranges</b>	Depends on the fibre-optic cable used											
<b>Through-beam system</b>												
Scanning distance, max. typical <sup>1)</sup>	0...65 mm											
	0...110 mm w. special fibre-optic cable											
Scanning range <sup>1)</sup>	0...50 mm											
	0...90 mm w. special fibre-optic cable											
<b>Proximity system</b>												
Scanning range, max. typical	0...800 mm											
Operating range	0...700 mm											
Sensitivity	Adjustable, potentiometer 270°											
<b>Light source<sup>2)</sup>, light type</b>												
Light source <sup>2)</sup> , light type	LED, visible red light											
Light spot diameter	Depends on scanning range											
Aperture fibre-optic cable	Approx. 65°											
<b>Supply voltage V<sub>S</sub><sup>3)</sup></b>												
Supply voltage V <sub>S</sub> <sup>3)</sup>	12...240 V DC											
	24...240 V AC											
Power consumption	≤ 5 VA											
<b>Switching output</b>												
Switching output	Relay, SPST, electrically isolated											
Switching current I <sub>A</sub> max. <sup>4)</sup>	3 A/240 V AC; 3 A/30 V DC											
Light receiver, switching mode	Light /dark-switching by rotary switch											
Response time	≤ 20 ms											
Max. switching frequency <sup>5)</sup>	25/s											
<b>Time delays</b>												
Time delays	With indicator LED: switching output active											
Switch position: «1 O.S.D.»	1: «One shot»											
«2 OFF.D.»	OFF delay t <sub>OFF</sub>											
«3 ON.D.»	ON delay t <sub>ON</sub>											
«4 Normal»	No delay											
<b>Time range</b>												
Time range	Adjustable, 0.1...5 s; potentiometer 270°											
<b>Connection type</b>												
Connection type	Terminal chamber											
<b>VDE protection class<sup>6)</sup></b>												
VDE protection class <sup>6)</sup>	□											
<b>Circuit protection<sup>7)</sup></b>												
Circuit protection <sup>7)</sup>	A, C											
<b>Enclosure rating</b>												
Enclosure rating	IP 66											
<b>Ambient temperature T<sub>A</sub></b>												
Ambient temperature T <sub>A</sub>	Operation -25 °C...+55 °C											
	Storage -40 °C...+70 °C											
<b>Weight</b>												
Weight	Approx. 120 g											
<b>Material</b>												
Material	Housing: ABS											

1) Object with 90 % remission (based on standard white DIN 5033)  
2) Average service life 100,000 h at T<sub>A</sub> = +25 °C

3) ± 10 %  
4) Provide suitable spark suppression for inductive or capacitive loads  
5) With light/dark ratio 1:1

6) Reference voltage 50 V DC  
7) A = V<sub>S</sub> connections reverse-polarity protected  
C = Interference suppression

Order information	
Type	Part no.
WLL 260-S 240	6 009 504
WLL 260-R 240	6 009 503